

UDC2300

Universal Digital Controller

RS422/485 ASCII Communications Option

Product Manual

Doc. No.: 51-52-25-85
Release: A
Last Revision Date: 10/00

Copyright, Notices, and Trademarks

Printed in U.S.A. – © Copyright 2000 by Honeywell

Rev. A – October, 2000

WARRANTY/REMEDY

Honeywell warrants goods of its manufacture as being free of defective materials and faulty workmanship. Contact your local sales office for warranty information. If warranted goods are returned to Honeywell during the period of coverage, Honeywell will repair or replace without charge those items it finds defective. The foregoing is Buyer's sole remedy and is **in lieu of all other warranties, expressed or implied, including those of merchantability and fitness for a particular purpose.** Specifications may change without notice. The information we supply is believed to be accurate and reliable as of this printing. However, we assume no responsibility for its use.

While we provide application assistance personally, through our literature and the Honeywell web site, it is up to the customer to determine the suitability of the product in the application.

This document was prepared using Information Mapping® methodologies and formatting principles.

Sensing and Control
Honeywell
11 West Spring Street
Freeport, Illinois 61032

UDC2300 is a U.S. trademark of Honeywell

Information Mapping® is a registered trademark of Information Mapping, Inc.

About This Publication

The UDC manual for RS422/485 ASCII communications option contains the following sections:

- Section 1 – Overview
- Section 2 – Installation
- Section 3 – Establishing Communications
- Section 4 – Read and Write Operations
- Section 5 – Reading, Writing, and Overriding Parameters on UDC2300
Universal/Digital Controllers
- Section 6 – Operating the Controller with Communications Option
- Section 7 – ASCII Conversion Table
- Section 8 – Cable Specifications

Communication between your computer and the UDC Controller is accomplished for one piece of information (parameter) at a time. Each parameter has an associated identifying code.

The Identifying Code and Format Code will be listed along with information pertaining to that parameter.

The identifying codes are grouped in the same order as they appear in the controller configuration prompts.

Contacts

World Wide Web

The following lists Honeywell's World Wide Web sites that will be of interest to our customers.

Honeywell Organization	WWW Address (URL)
Corporate	http://www.honeywell.com
Sensing and Control	http://www.honeywell.com/sensing
International	http://www.honeywell.com/Business/global.asp













Telephone

Contact us by telephone at the numbers listed below.

	Organization	Phone Number
United States and Canada	Honeywell	1-800-423-9883 Tech. Support 1-888-423-9883 Q&A Faxback (TACFACS) 1-800-525-7439 Service
Asia Pacific	Honeywell Asia Pacific Hong Kong	(852) 2829-8298
Europe	Honeywell PACE, Brussels, Belgium	[32-2] 728-2111
Latin America	Honeywell, Sunrise, Florida U.S.A.	(854) 845-2600

Symbol Definitions

The following table lists those symbols that may be used in this document to denote certain conditions.

Symbol	Definition
	This DANGER symbol indicates an imminently hazardous situation, which, if not avoided, will result in death or serious injury .
	This WARNING symbol indicates a potentially hazardous situation, which, if not avoided, could result in death or serious injury .
	This CAUTION symbol may be present on Control Product instrumentation and literature. If present on a product, the user must consult the appropriate part of the accompanying product literature for more information.
	This CAUTION symbol indicates a potentially hazardous situation, which, if not avoided, may result in property damage .
	WARNING PERSONAL INJURY: Risk of electrical shock. This symbol warns the user of a potential shock hazard where HAZARDOUS LIVE voltages greater than 30 Vrms, 42.4 Vpeak, or 60 Vdc may be accessible. Failure to comply with these instructions could result in death or serious injury.
	ATTENTION, Electrostatic Discharge (ESD) hazards. Observe precautions for handling electrostatic sensitive devices
	Protective Earth (PE) terminal. Provided for connection of the protective earth (green or green/yellow) supply system conductor.
	Functional earth terminal. Used for non-safety purposes such as noise immunity improvement. NOTE: This connection shall be bonded to protective earth at the source of supply in accordance with national local electrical code requirements.
	Earth Ground. Functional earth connection. NOTE: This connection shall be bonded to Protective earth at the source of supply in accordance with national and local electrical code requirements.
	Chassis Ground. Identifies a connection to the chassis or frame of the equipment shall be bonded to Protective Earth at the source of supply in accordance with national and local electrical code requirements.
	Earth Ground. Functional earth connection. NOTE: This connection shall be bonded to Protective earth at the source of supply in accordance with national and local electrical code requirements.
	Chassis Ground. Identifies a connection to the chassis or frame of the equipment shall be bonded to Protective Earth at the source of supply in accordance with national and local electrical code requirements.

Contents

SECTION 1 – OVERVIEW.....	1
1.1 Introduction.....	1
1.2 Message Exchange Protocols.....	2
1.3 Field Upgrade.....	3
SECTION 2 – INSTALLATION.....	5
2.1 Introduction.....	5
2.2 RS232 to RS485 Converters.....	6
2.3 Using a Black Box Converter.....	7
2.4 Using a Westermo Converter.....	9
2.5 Wiring Diagrams.....	11
SECTION 3 – ESTABLISHING COMMUNICATIONS AND TESTING.....	13
3.1 Preparing the Controller for Communications.....	13
3.2 Programming Your Computer.....	18
3.3 Message Exchange.....	19
3.4 Request Messages.....	20
3.5 Response Messages.....	23
3.6 Status Codes.....	25
3.7 Checksum Protocol (for Data Security).....	27
3.8 Shed.....	33
3.9 Loopback.....	34
3.10 Recovering from Communications Failures.....	36
SECTION 4 – READ AND WRITE OPERATIONS.....	39
4.1 Read Operations.....	39
4.2 Read Analog Parameters.....	40
4.3 Read Digital Parameters.....	43
4.4 Write Operations.....	45
4.5 Write Analog Parameters.....	46
4.6 Write Digital Parameters.....	50
SECTION 5 – READ, WRITE AND OVERRIDE PARAMETERS ON UDC2300	
PROCESS CONTROLLERS.....	53
5.1 Overview.....	53
5.2 Reading Control Data – UDC2300.....	55
5.3 Read Options Status – UDC2300.....	56
5.4 Miscellaneous Read Only's – UDC2300.....	57
5.5 Setpoints – UDC2300.....	59
5.6 Using a Computer Setpoint (Overriding Controller Setpoint) – UDC2300..	60
5.7 PV or Setpoint Override Selections – UDC2300.....	62
5.8 Reading or Changing the Output – UDC2300.....	63
5.9 Local Setpoint/PID Selection/Setpoint Ramp Status – UDC2300.....	64
5.10 Configuration Parameters – UDC2300.....	67

SECTION 6 – OPERATING THE CONTROLLER WITH COMMUNICATIONS OPTION	85
6.1 Operation	85
SECTION 7 – ASCII CONVERSION TABLE.....	87
7.1 Overview	87
SECTION 8 – CABLE SPECIFICATIONS	89
8.1 Introduction	89

Figures

Figure 2-1	Black Box Converter Wiring Connections.....	8
Figure 2-2	Recommended Switch Settings for Westermo Converter	10
Figure 2-3	Westermo Converter Wiring Connections	10
Figure 2-4	UDC2300 Connections.....	11
Figure 3-1	Message Exchanges	19
Figure 3-2	Request Message Fields	20
Figure 3-3	Response Message Fields Information	23
Figure 3-4	Request Format for Checksum Protocol	27
Figure 3-5	Example of Checksum Calculation.....	29
Figure 3-6	Using Checksum Protocol.....	30
Figure 3-7	Success Response Message Fields.....	31
Figure 3-8	Failure Response Message Fields	32
Figure 3-9	Lost Messages	36
Figure 3-10	Timing a Message Exchange and Checking for a Response.....	37
Figure 4-1	Read Analog Parameter Message Exchange	42
Figure 4-2	Read Digital Parameter Message Exchange.....	44
Figure 4-3	Write Analog Parameter Message Exchange Example.....	49
Figure 4-4	Write Digital Parameter Message Exchange Example.....	52
Figure 5-1	Option Status Information.....	56
Figure 5-2	I.D. Code 250 Indications	65

Tables

Table 1-1	Rules and Regulations for Configuration Protocol	2
Table 2-1	Converters	6
Table 2-2	Black Box Converter Wiring Connections Procedure	7
Table 2-3	Terminal Connections for Black Box Converters	8
Table 2-4	Westermo Converter Configuration and Wiring Procedure.....	9
Table 2-5	Terminal Connections for Westermo Converters.....	10
Table 3-1	Communications Parameters.....	13
Table 3-2	Controller Procedure for Communication Parameters	16
Table 3-3	Programming Statements	18
Table 3-4	Request Message Fields Definitions.....	21
Table 3-5	Response Message Fields Definitions	24
Table 3-6	Request Message Status Codes	25
Table 3-7	UDC Status Codes.....	26
Table 3-8	Calculating the Checksum Procedure.....	28
Table 3-9	Example of Loopback Request Message	34
Table 3-10	Example of Loopback Response Message.....	35
Table 3-11	Programming Example	35
Table 4-1	Analog Parameter Request Format	40
Table 4-2	Analog Parameter Response Format	41
Table 4-3	Digital Parameter Request Format	43
Table 4-4	Digital Parameter Response Format.....	44
Table 4-5	Write Message Exchange Steps.....	45
Table 4-6	Write Request Format for Analog I.D. Codes	46
Table 4-7	Busy Response.....	47
Table 4-8	Ready Requests	47
Table 4-9	Is Ready Response.....	48
Table 4-10	Write Request Format for Digital I.D. Codes.....	50
Table 4-11	Busy Response.....	51
Table 4-12	Ready Request	51
Table 4-13	Is Ready Response.....	51
Table 5-1	Control Data Parameters	55
Table 5-2	Option Status	56
Table 5-3	Miscellaneous Read Only's.....	57
Table 5-4	Error Status Definitions	58
Table 5-5	Setpoint Code Selections.....	59
Table 5-6	Setpoint Associated Parameters.....	59
Table 5-7	Computer Setpoint Selection	60
Table 5-8	Computer Setpoint Associated Parameters.....	61
Table 5-9	PV or Setpoint Override Selections	62
Table 5-10	Reading or Changing the Output	63
Table 5-11	Associated Output Codes	63
Table 5-12	LSP/PID Set Selection and Setpoint Ramp Status	64
Table 5-13	I.D. Code 250 Writes.....	66
Table 5-14	Setup Group – Timer	68
Table 5-15	Setup Group – Tuning.....	68
Table 5-16	Setup Group – Setpoint Ramp/Rate Program	70
Table 5-17	Setup Group – Adaptive Tune	72
Table 5-18	Setup Group – Algorithm	73
Table 5-19	Setup Group – Input 1.....	74
Table 5-20	Setup Group – Input 2.....	78
Table 5-21	Setup Group – Control.....	80

Table 5-22	Setup Group – Communications	82
Table 5-23	Setup Group – Alarms.....	83
Table 6-1	Emergency Manual Procedure.....	85
Table 7-1	ASCII Character Codes.....	87
Table 7-2	Hexadecimal to Binary.....	88
Table 8-1	Cable Specifications.....	89

Parameters

COMSTA Communication State
ComADD..... Communication Address (Loop 1)
SHDTIM..... Shed Time
PARITY.....Parity
BAUD RATE Baud Rate (bits/second)
SDMODE Controller Shed Mode and Output Level
SHD SP Shed Setpoint Recall
TX DLY Transmission Delay Timer
UNITS.....Communication Units
CSRATIO.....Commun. SP Ratio (Loop 1)
CSP BI.....Commun. SP Bias (Loop 1)

References

Publication Title	Publication Number
<i>UDC2300 Controller Product Manual</i>	51-52-25-73
<i>UDC2300 Controller User Guide</i>	51-52-25-83

Section 1 – Overview

1.1 Introduction

- The communications option** The RS422/485 Communications Option on the UDC2300 Controller provides a serial multi-drop link whereby up to 31 UDC controllers connect directly to a host computer.
- Monitor or slave mode** The UDC controller can be placed in monitor or slave by the host computer. When monitored, the controller will send Configuration, Tuning, and Operating parameters to the host computer. When in slave, the controller will be switched through the communications interface board to "Slave" operation. This means that the computer can write configuration or tuning information into any controller on the link including overriding of PV, the setpoint, and output.
- Message exchanges** The computer and the controllers talk to each other through a series of message exchanges. There are two RS422/485 message exchange protocols: Configuration or Loopback.

1.2 Message Exchange Protocols

Configuration protocol

Table 1-1 lists the rules and regulations of configuration protocol.

Table 1-1 Rules and Regulations for Configuration Protocol

Protocol	Rule
Data Type Transactions	The configuration protocol permits reading or writing of data type transactions such as PV, SP, or Output, as well as configuration type transactions such as Tuning, Algorithm selections, etc.
Read	Read transactions can be performed in either UDC state: Monitor or Slave.
Write	Write transactions can only be performed in the Slave mode.
Busy	Following any Write message, a Busy indication is returned.
Ready	A Ready transaction is required as the next message request to determine if the information received was correct.
Transaction Limits	In a Write transaction, only single items are permitted to be written, however, for Read transactions, single or multi-item parameters may be requested.

Loopback

Loopback protocol is also provided for link tests. With this message exchange you can test the Communications link between your computer and the controllers on the link. The host computer sends a series of ASCII characters to the desired device, and the device returns the characters it received to the host computer.

Checksum

There is an optional transaction called "Checksum" which is used to increase security on the RS422/485 link. Used with any message exchange, it enables both your computer and controller to detect messages that have been interrupted by line noise.

Controller Address

Each controller will have its own specific address.

Keyboard Configuration

Address, Baud Rate, and Parity are keyboard selectable as well as Shed Time, Shed Mode, and Output Level.

1.3 Field Upgrade

Adding the communications option

RS422/485 Communications Option can be added in the field by installing the proper RS422/485 Printed Wiring Board Assembly.

Part number 51309831-50 1 is required to add the RS422/485 Communication option Printed Wiring Board to the UDC2300 controller.

Section 2 – Installation

2.1 Introduction

General

The Installation section (Section 2) of the UDC Product Manual contains information and drawings required to mount and wire the controller. Refer to the Controller Product Manual for appropriate information regarding the basic installation requirements.

Electrical noise protection

When installing and wiring the controller, follow the practices that conform to all local codes and ordinances. In addition, be aware of the precautions you should take to avoid electrical noise.

Electrical noise is unwanted electrical signals that provide undesirable effects. Digital equipment is especially sensitive to the effects of electrical noise. The controller has built-in circuits to reduce the effects of this noise.

For information concerning further reduction of electrical noise, refer to 51-52-05-01, "How to Apply Digital Instrumentation in Severe Electrical Noise Environments."

What's in this section

This section contains the following information:

	Topic	See Page
2.1	Introduction	5
	General	5
	Electrical Noise Protection	5
2.2	RS232 to RS485 Converters	6
2.3	Using a Black Box Converter	7
	Wiring the Black Box converter and the link	7
	Wiring connections	8
	Link devices terminal connections	8
2.4	Using a Westermo Converter	9
	Wiring the Westermo converter and the link	9
	Configuring the Westermo converter and the link	10
	Wiring connections	10
	Link devices terminal connections	10
2.5	Wiring Diagrams	11

2.2 RS232 to RS485 Converters

Overview

Up to 31 UDC2300 controllers with an RS485 communications option can be connected to your computer by installing a Black Box or Westermo RS232 to RS485 converter between the RS232 port on your computer and the devices on the RS485 link.

Converters

Table 2-1 lists the specific information needed to procure either of these converters.

Table 2-1 Converters

Arrangement	Description
Black Box Converter	<p>Using the RS232 port and a Black Box RS232 to RS485 converter installed between the RS232 port and the first device on the link.</p> <p>This converter is available from . . .</p> <p>Black Box Corp Pittsburgh, PA</p> <p><i>Model</i> IC109A - Stand alone RS232 to RS485/422 converter with opto-isolation</p>
Westermo Converter (Europe)	<p>Using the RS232 port and a Westermo RS232 to RS485 converter installed between the RS232 port and the first device on the link.</p> <p>The Westermo converter can be ordered from a Honeywell sales office, Part Number 46210088-001.</p> <p>A 2 meter shielded cable with Female/Male DB9/DB25 connectors for use between the PC communication port and the Westermo box is also available, Part Number 46210061-002</p>

2.3 Using a Black Box Converter

Wiring the Black Box converter and the link

Figure 2-1 shows the wiring diagram and terminal connections for wiring the RS232 to RS485 Black Box converter.

Follow the procedure in Table 2-2 to wire the Black Box converter.

Table 2-3 shows the terminal designation for the devices on the link.

Table 2-2 Black Box Converter Wiring Connections Procedure

Step	Action																						
1	Install an appropriate Serial Communication Connector between the Computer serial port and the RS232 input connector of the Black Box converter. See the Black Box data sheet for the required interfacing signals.																						
2	Connect one wire to terminal 2 (-).																						
3	Connect other wire to terminal 1 (+).																						
4	Connect a 120 ohm resistor across 1 and 2.																						
5	Set the jumpers on the Black Box converter Printed Circuit Board as follows: <table border="0" style="margin-left: 40px;"> <thead> <tr> <th>JUMPER</th> <th>SETTING</th> </tr> </thead> <tbody> <tr> <td>XW1A</td> <td>DCE</td> </tr> <tr> <td>W8</td> <td>B-C (2-wire)</td> </tr> <tr> <td>W15</td> <td>B-C (Data Enabled)</td> </tr> <tr> <td>W5</td> <td>A-B (RTS/CTS delay - normal)</td> </tr> <tr> <td>W9</td> <td>C (0 msec)</td> </tr> <tr> <td>W17</td> <td>C (2 msec)</td> </tr> <tr> <td>W16</td> <td>B (0.1 msec)</td> </tr> <tr> <td>S1</td> <td>OUT (Normal)</td> </tr> <tr> <td>S2</td> <td>ON (RS485 Receiver Terminated)</td> </tr> <tr> <td>S3</td> <td>ON (Line Bias On)</td> </tr> </tbody> </table>	JUMPER	SETTING	XW1A	DCE	W8	B-C (2-wire)	W15	B-C (Data Enabled)	W5	A-B (RTS/CTS delay - normal)	W9	C (0 msec)	W17	C (2 msec)	W16	B (0.1 msec)	S1	OUT (Normal)	S2	ON (RS485 Receiver Terminated)	S3	ON (Line Bias On)
JUMPER	SETTING																						
XW1A	DCE																						
W8	B-C (2-wire)																						
W15	B-C (Data Enabled)																						
W5	A-B (RTS/CTS delay - normal)																						
W9	C (0 msec)																						
W17	C (2 msec)																						
W16	B (0.1 msec)																						
S1	OUT (Normal)																						
S2	ON (RS485 Receiver Terminated)																						
S3	ON (Line Bias On)																						
6	Create a chain of up to 31 devices by connecting them with shielded twisted pair wiring (Belden 9271 Twinax or equivalent) to a maximum total length of 4000 feet (1250 meters). (See Section 8—Cable Specifications.) REFER TO TABLE 2-3 FOR TERMINAL DESIGNATIONS OF THE DEVICES ON THE LINK																						

2.3 Using a Black Box Converter, Continued

Black Box wiring connections

Figure 2-1 shows the wiring for the Black Box converter and the devices on the link.

Figure 2-1 Black Box Converter Wiring Connections

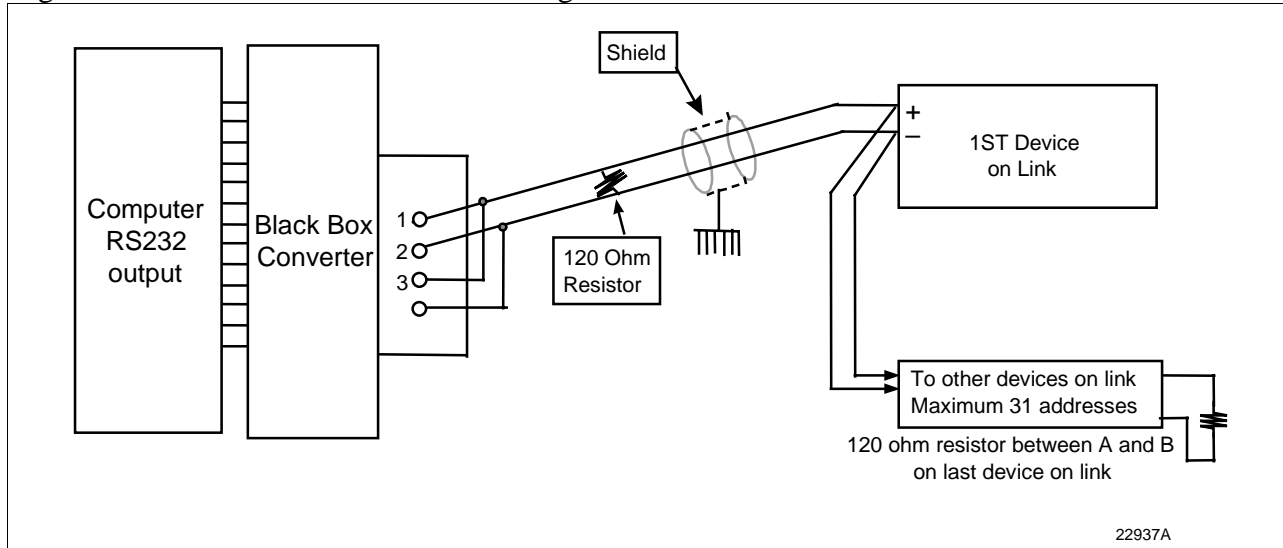

Link devices terminal connections

Table 2-3 lists the terminal connections between the Black Box converter and the devices on the communication link.

Table 2-3 Terminal Connections for Black Box Converters

BLACK BOX	UDC2300
2	14
1	13

2.4 Using a Westermo Converter

Wiring the Westermo converter and the link

Figure 2-2 shows the recommended switch setting for the WESTERMO converter.

Figure 2-3 shows the wiring diagram and terminal connections for wiring the RS485 Westermo converter.

Follow the procedure in Table 2-4 to configure and wire the Westermo converter.

Table 2-5 shows the terminal designation for the devices on the link.

Table 2-4 Westermo Converter Configuration and Wiring Procedure

Step	Action
1	Install an appropriate Serial Communication Connector between the Computer serial port and the RS232 input connector of the Westermo converter. See the Westermo data sheet for the required interfacing signals.
2	Configure the switch settings on the Westermo converter as shown in Figure 2-6.
3	Connect the shield to terminal 5. See Figure 2-3.
4	Connect one wire to terminal 3 (-).
5	Connect other wire to terminal 4 (+).
6	Connect a 120 ohm resistor across terminals 3 and 4.
7	Create a chain of up to 31 Devices by connecting them with shielded twisted pair wiring (Belden 9271 Twinax or equivalent) to a maximum total length of 4000 feet (1250 meters). (See Section 8—Cable Specifications.) REFER TO TABLE 2-5 FOR TERMINAL DESIGNATIONS OF THE DEVICES ON THE LINK

2.4 Using a Westermo Converter, Continued

Configuring the WESTERMO Converter

Figure 2-2 shows the recommended switch settings for the WESTERMO converter.

Figure 2-2 Recommended Switch Settings for Westermo Converter

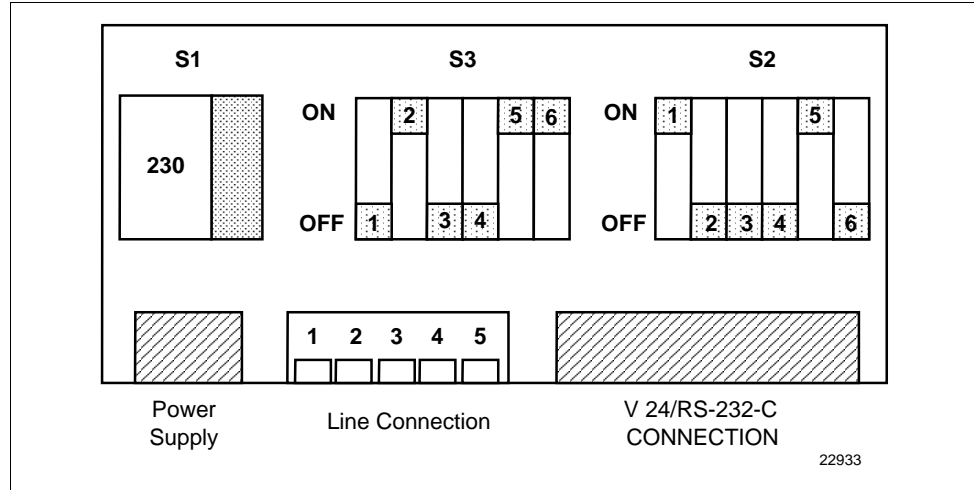

Westermo wiring connections

Figure 2-3 shows the wiring for the Westermo converter and the devices on the link.

Figure 2-3 Westermo Converter Wiring Connections

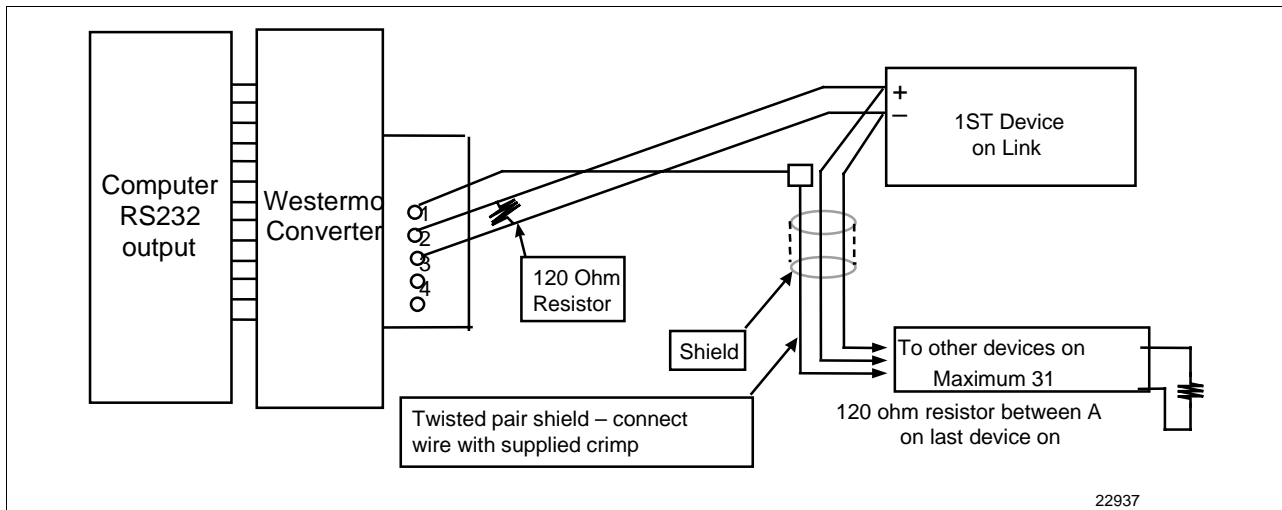

Link devices terminal connections

Table 2-5 shows the terminal connections between the Westermo converter and the devices on the communication link.

Table 2-5 Terminal Connections for Westermo Converters

Westermo Line Connections	UDC2300
3	14
4	13

2.5 Wiring Diagrams

Communications option connections

Figure 2-4 UDC2300 Connections

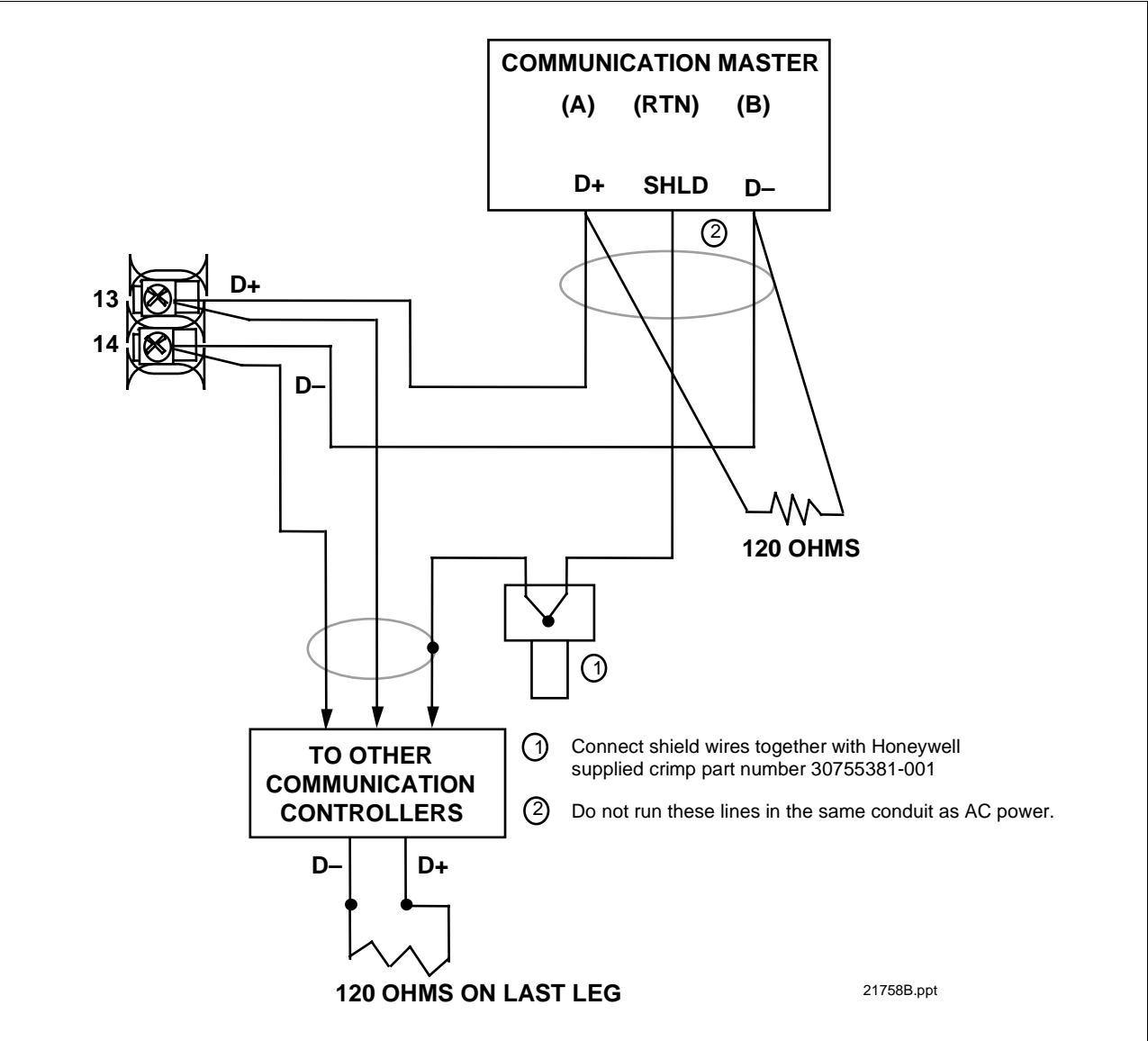

Section 3 – Establishing Communications and Testing

3.1 Preparing the Controller for Communications

Introduction

Each controller on the RS422/485 Communications link must be configured at the controller level for certain parameters before communications between the Host and the Controller can be accomplished.

Synchronization

Before you attempt to exchange messages between your computer and the controllers on the RS422/485 link, you must set up the controller for the same form of data transmission that the host computer's RS422/485 interface uses. This is called Synchronization.

You must match the controller Baud Rate and Parity with that of your computer.

Configurable parameters

Table 3-1 is a list of parameters that should be configured with their definitions and range of settings or selections. The procedure for entering the information into the controller is found in Table 3-2.

Table 3-1 Communications Parameters

Parameter	Definition
Communications State	Enables or disables the Communication function in the controller.
Communications Address	This is a number that is assigned to a controller (limited to 31 controllers) that will be used during communications. This number will be its address on the link (address 0-99).
Shed Enable	Term used to describe a point in time when the controller, which had been working as a slave, reverts to an independent, stand alone controller using its own inputs, configuration data and control mode. Shed will happen when a controller is in slave, the shed is not zero, and the communication stops. This selection enables or disables the Shed function.
Shed Time	The number selected will represent how many sample periods will elapse before the controller sheds from computer control. Each period equals 1/3 second. 0 = No shed.

3.1 Preparing the Controller for Communications, Continued

Parameters,
continued

Table 3-1 Communications Parameters, Continued

Parameter	Definition		
Parity	Transmitting each ASCII character requires 8 bits: <ul style="list-style-type: none"> • 7 bits for the character code • 1 bit (the eighth) for Parity, which may represent either ODD or EVEN parity. Thus, the controller can accommodate your computer's choice of parity (odd or even) and perform parity checks on your computer's data transmission. The controller will return STATUS CODE 04 if it detects incorrect parity.		
Baud Rate	This is the transmission speed in bits per second. In order to communicate properly, the controller must be set to the same Baud Rate as your computer. The Baud Rate selections are: 2400, 4800, 9600, 19200 .		
TX Delay	Configurable response delay timer allows you to force the UDC to delay its response for a time period of from 1 to 500 milliseconds. Compatible with the host system hardware/software.		
Word/Byte Order	This selection determines the Word/Byte Order for floating point communications data.		
	Selection	Description	Byte order
	FP B	Floating Point Big Endian Format	4, 3, 2, 1
	FP BB	Floating Point Big Endian with byte-swapped	3, 4, 1, 2
	FP L	Floating Point Little Endian Format	1, 2, 3, 4
FP LB	Floating Point Little Endian with byte-swapped	2, 1, 4, 3	
Shed Controller Mode and Output Level	This selection determines the mode of local control whenever the controller is SHED from the slave mode. <ul style="list-style-type: none"> • Last Mode and Output – The controller will return to the same mode (Manual or Automatic) and Output level that it was in before shed. • Manual Mode, Last Output – The controller will return to manual mode and the last output level it was in before shed. • Manual Mode, Failsafe Output – The controller will return to manual mode at the output level selected at ID code 40 – Failsafe Output Level. • Shed to Automatic Mode – The controller will return to automatic mode. 		

3.1 Preparing the Controller for Communications, Continued

Parameters,
continued

Table 3-1 Communications Parameters, Continued

Parameter	Definition
Shed Setpoint Recall	This selection determines what setpoint will be used if the controller is shed from the communications link. <ul style="list-style-type: none">• LSP – The controller will use the last local setpoint stored.• CSP – The controller will store the last computer setpoint and use it at the Local Setpoint (LSP1, LSP2, whichever is in use).
Communication Units	This selection determines how the controller values are expressed during communications: Percent of Span or Engineering Units.
Communications Setpoint Ratio	Ratio value for computer setpoint. The range is from –20.00 to +20.00.
Communications Setpoint Bias	Bias value for computer setpoint. The range is from –999 to 9999.

3.1 Preparing the Controller for Communications, Continued

Procedure The procedure in Table 3-2 tells you what keys to press on the controller keyboard, the upper and lower display indications, and the range of settings available to you.

Use ▲▼ to make adjustments to the range of setting or selection.

Table 3-2 Controller Procedure for Communication Parameters

Step	Press	Lower Display	Upper Display Range of Setting or Selection	Parameter Description
1	Set Up	COM		Communications
2	Function	Successive presses of the [FUNCTION] key will sequentially display all the functions and their values or selections.		
		COMSTA	DIS R422 MODB	Communication State
		ComADD	01 to 99* *Address 00 disconnects it from the link.	Communication Address
		SDENAB	DIS ENAB	Disable/Enable Shed Function
		SHDTIM	0 to 255 Sample periods 0 = No Shed will occur	Shed Time
		PARITY	ODD EVEN	Parity
		BAUD	2400 4800 9600 19200	Baud Rate (bits/second)
		TX DLY	1 to 500 milliseconds	Transmission Delay Timer
		WS FLT	FP B FPBB FP L FPLB	Word/Byte Order for Floating Point Communications Data
		SDMODE	LAST MAN FSAF AUTO	Controller Shed Mode and Output Level
		SHD.SP	LSP CSP	Shed Setpoint Recall

3.1 Preparing the Controller for Communications, Continued

Procedure, continued

Table 3-2 Controller Procedure for Communication Parameters, Continued

Step	Press	Lower Display	Upper Display Range of Setting or Selection	Parameter Description
		UNITS	PCT Eng	Communication Units
		CS RATIO	-20.00 to +20.00	Communications SP Ratio
		CSP BI	-999 to +9999	Communications SP Bias
3	DISPLAY	TO RETURN TO NORMAL CONTROL		

3.2 Programming Your Computer

Introduction To program your computer for communication with the various controllers on the link, you write input and output statements to send and receive ASCII character strings to and from the controller. (See ASCII and Hexadecimal conversion table in Section 7.) You treat the controller like any I/O device.

Request To send a request, you program your computer to output the appropriate character string to the controller.

Response To get a response, you program your computer to input the expected character string from the controller.

Example The following programming statements show how you would output a request message and read the resulting response. This example is written in Fortran and uses the following assignments:

- I/O Channel 5 for your computer's RS422/485 Transmit Data Line.
- I/O Channel 6 for your computer's RS422/485 Receive Data Line.
- I/O Channel 7 for your computer's printer or terminal.

Table 3-3 lists the programming statements for this example.

Table 3-3 Programming Statements

Step	Statement	Action
Sending the Request	10 Write (5,20) 20 Format ("XXXXXXX")	Writing the character string the character string XXXXXXX to I/O channel 5 which transmits the character string XXXXXXX to the controller.
Getting the Response	30 Read (6,40) Reply 40 Format (12)	Reading the character string at I/O Channel 6 which receives data from the controller into reply.
Displaying the Response	50 Write (7,60) Reply 60 Format (12)	Writing the contents of Reply to I/O Channel 7, a printer or terminal.

3.3 Message Exchange

What is a message exchange?

Your computer communicates with the UDC controllers using the RS422/485 link. Each communication takes place as a message exchange: Your computer sends a request message (ASCII characters), and then waits for the resulting response from the controller involved (ASCII characters). Figure 3-1 shows how this occurs.

Figure 3-1 Message Exchanges

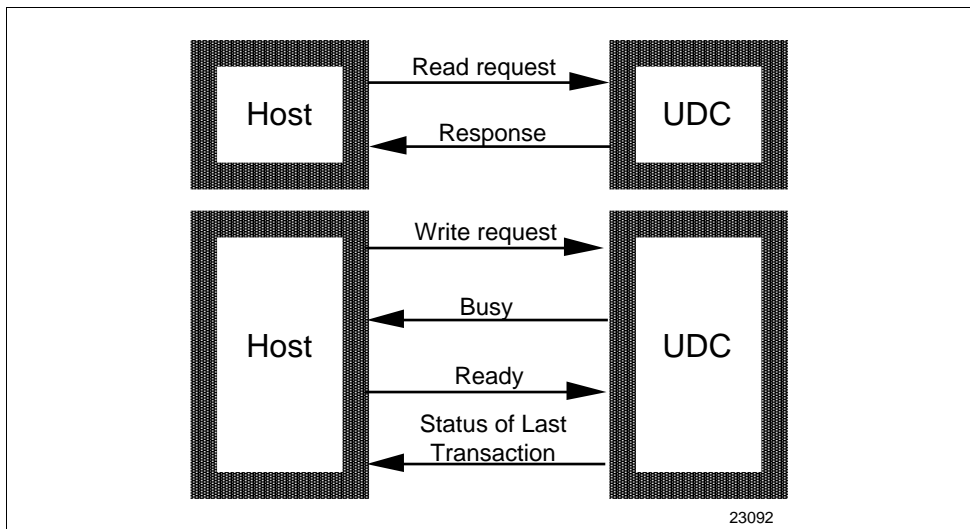

Sending requests

Your computer is the host, it initiates a message exchange. The UDC controllers are respond-only devices.

When you send a Read request, the UDC responds with the data requested. If you write configuration or override data into a UDC, the UDC responds with a Busy message (0082xx). The host should send a Ready message at which time the UDC will respond with a status of the write transaction. Communication with a single UDC should not be faster than 1/3 second.

Until the UDC completes processing of the data, any subsequent valid message received is answered with a busy response.

3.4 Request Messages

What is a request message?

Your computer queries a controller and indicates the communication function, or operation, that the controller should perform by sending a request message. Request messages are composed of standard fields, separated by commas. Each field contains a certain kind of information, which you must enter in order to have a valid request message.

Request message fields

Figure 3-2 shows the request message fields and the selections that may be entered into each field. Table 3-4 lists these selections and their definitions.

Figure 3-2 Request Message Fields

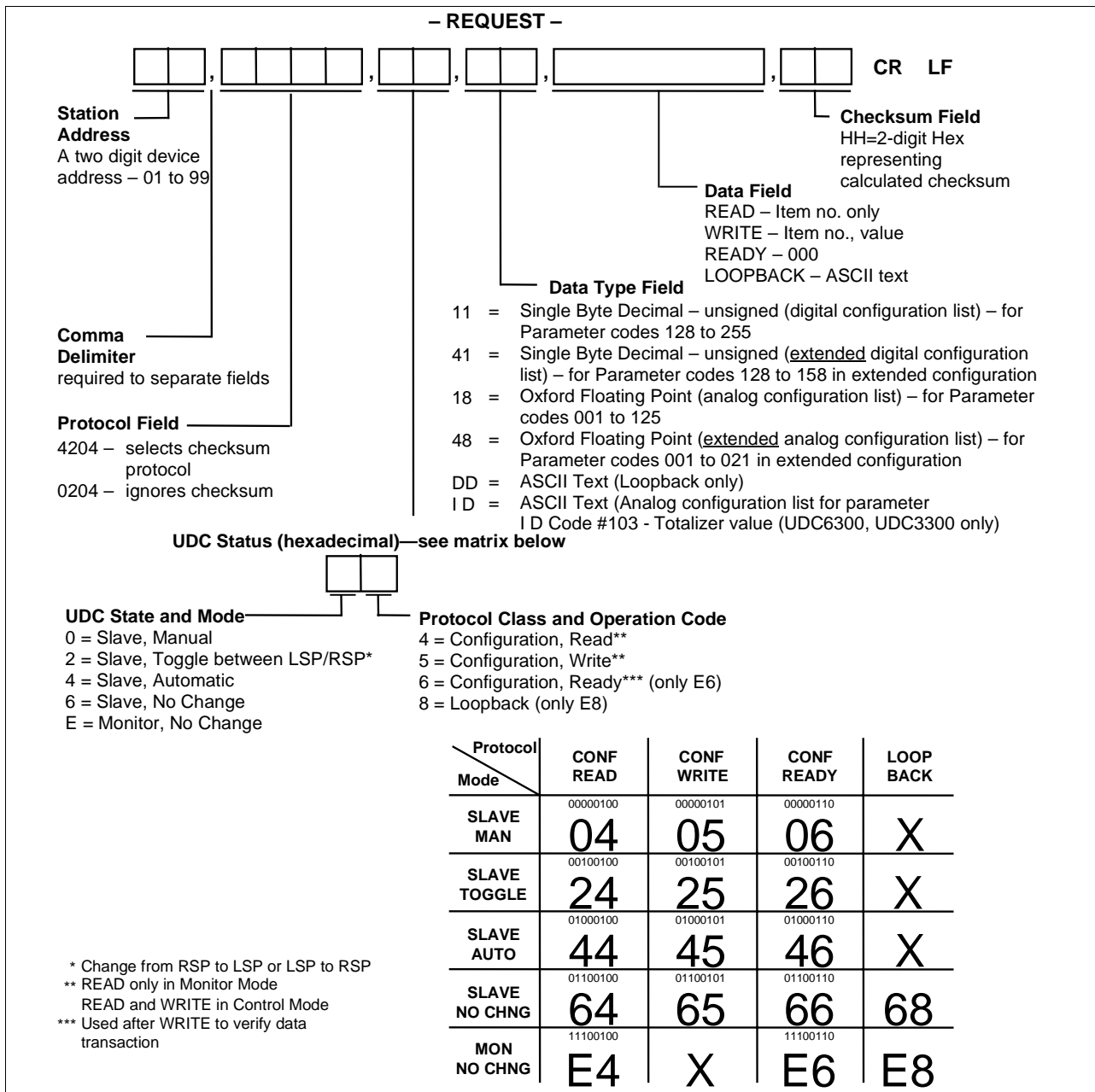

3.4 Request Messages, Continued

Request message field selections

Table 3-4 is a list of selections for the request message fields and their definitions.

Table 3-4 Request Message Fields Definitions

Selection	Definition
Station Address	<p>A two-digit device address – from 01 to 99 – that identifies the specific controller you are addressing. You must assign a unique station address to each controller on the link.</p> <p>See "Preparing the Controller for Communications" in this manual. A UDC will not respond to address 0 since the address results in a disconnect.</p>
Protocol Field	<p>A four-digit number that selects whether or not you are going to use a Checksum Protocol (for increased data security) with your message exchange.</p> <ul style="list-style-type: none"> • 4204 selects Checksum Protocol <ul style="list-style-type: none"> – see "Checksum Protocol" • 0204 ignores Checksum Protocol <p>Any sequence utilizing other than 4 or 0 in the first digit results in an error with an error message returned.</p>
UDC State and Mode	<p>A hexadecimal number that determines what state you want the UDC to be in (monitor or slave) and the mode of operation desired (manual or automatic). You can also change the controller setpoint from Local setpoint to Remote setpoint or vice-versa.</p> <div style="border: 1px solid black; padding: 5px; margin-top: 10px;"> <p>NOTICE</p> <p>Any change made in UDC State or Control mode will not be indicated in the response until the next transaction.</p> </div>
Protocol Class and Operation Code	<p>A hexadecimal number that allows you to do a Loopback or do a READ, WRITE, or READY transaction.</p>

3.4 Request Messages, Continued

Request message field selections, continued

Table 3-4 Request Message Fields Definitions, Continued

Selection	Definition
Data Type Field	<p>A two-digit number that specifies the format, or data type, of each of the parameters that can be accessed in the UDC controller.</p> <p>11 = Single Byte Decimal (unsigned) – used with configuration protocol for <u>digital</u> parameter code numbers 128 through 255.</p> <p>18 = Floating Point Format – used with configuration protocol for <u>analog</u> parameters code numbers 001 through 125.</p> <p>DD = ASCII Text – Used with loopback protocol only.</p>
Data Field	<p>The data in this field is determined by the type of request:</p> <ul style="list-style-type: none"> • READ – three digit parameter code which identifies a particular parameter for which you want to know the value or selection. • WRITE – three digit parameter code, which identifies a particular parameter you want to change, a comma (,), and the value or selection you want to enter. • READY – three zero's (000) – used in conjunction with a write request. Sent after a write request to verify that the information transmitted was received. • LOOPBACK – ASCII Text
Checksum Field (Optional)	<p>This field is a one byte hexadecimal value (two ASCII characters) representing the binary sum, ignoring carries, generated by adding the ASCII code for each character in the message exchange, up to but not including the checksum and the CR and LF characters.</p> <ul style="list-style-type: none"> • No Characters = No Checksum • HH = two digit hexadecimal number representing the calculated checksum
Carriage Return/Line Feed	<p>Terminates a message. The message will not be exchanged unless used in this order (CR LF).</p>

3.5 Response Messages, Continued

Response message field Information

Table 3-5 is a list of the information contained in the response message and their definitions.

Table 3-5 Response Message Fields Definitions

Type of Information	Definition
Request Message Status Code	A two-digit code that indicates whether or not the present request message was successfully processed. For detailed explanations and recovery procedures for these codes, refer to 'Request Message Status Codes' in this section.
UDC Status Code	A two-digit code that indicates whether or not the UDC controller addressed is working correctly and has performed the requested operation. For detailed explanations and recovery procedures for these codes, refer to "UDC Status Codes" in this section.
UDC State and Mode	<p>A hexadecimal number that indicates whether the UDC controller's present state is "Slave" or "Monitor" and whether it is in Manual or Automatic mode using the Local setpoint or Remote setpoint.</p> <div data-bbox="743 982 1406 1129" style="border: 1px solid black; padding: 5px;"> <p>NOTICE</p> <p>Any change made in UDC State or Control mode will not be indicated in the response until the next transaction.</p> </div>
Alarm Status	A hexadecimal number that indicates the status of Alarm #1 and #2 or both. It indicates when the Alarm is on or has changed state since last communication. The change of state indicator is a backup to the on/off state indicator. If an alarm goes from off to on then off in between consecutive communications, the on/off would not show it. The change of state flag would show that it had happened.
Data Field	This field always returns the identifying number for the parameter in the request message and the value for that parameter (either an integer or field floating decimal point).
Optional Checksum Field	This field is a one byte hexadecimal value (two ASCII characters) representing the binary sum, ignoring carries, generated by adding the ASCII code for each character of the response message, ignoring parity, up to but not including the checksum. It is returned for 4204 requests only. See "Checksum Protocol" in this section.

3.6 Status Codes

Request message status codes

The codes, listed in Table 3-6, indicate whether or not the request message was successfully processed. A suggested recovery procedure is listed for those that indicate an error.

Table 3-6 Request Message Status Codes

Request Message Status Code	Explanation	Suggested Recovery
00	The request message was successfully processed.	Not applicable.
01	Request message format invalid.	Check format of request message. Re-send message.
02	Request is invalid. The controller addressed does not support the requested operation.	Check parameter identifying code and value.
04	Checksum indicated in the request message differs from the checksum the UDC calculated. Or UDC has detected incorrect parity for character transmitted in request.	Check checksum calculations. Re-send message.

3.6 Status Codes, Continued

UDC status codes All the controllers on the link return the UDC Status Codes listed in Table 3-7. A suggested recovery procedure is listed for those that indicate an error.

Table 3-7 UDC Status Codes

UDC Status Code	Explanation	Example	Suggested Recovery
00	UDC functioning properly and has received the message correctly.		Not applicable.
01	UDC has received invalid data from the computer and did not perform the requested operation.	Data error: Configuration item number incorrect, data out-of-range or incorrect.	Check the UDC's configuration and limits.
02	UDC is busy until the data received is processed.	Returned after each write when a controller is processing a change to configuration database.	<ol style="list-style-type: none"> 1. Do ready request to see if information received. 2. Wait, then re-send request.
04	UDC cannot perform the requested operation in its current mode.	<ol style="list-style-type: none"> 1. Request error, request illegal, request incorrect in present state (Calib). 2. Requested illegal mode change. 3. Data received in wrong format. 	Check configuration with last request. Check data field and data type field.
06	The UDC is performing Accutune.	Returned when the controller is performing the Accutune function.	Wait or stop Accutune, then re-send message.
07	UDC unable to perform request at present time.	May occur during writes to EEPROM or when unit is in set up and data changing via the keyboard.	Wait, re-send request.
+80	UDC status change	Indicates one or more of the following have changed.*	Read 255 code. Clear by writing to 255 code.

*Emergency manual, Failsafe, Working calibration checksum error, Configuration checksum error, Factory calibration error, Hardware failure, Restart after shed, Configuration/calibration memory changed.

3.7 Checksum Protocol (for Data Security)

Introduction

The optional Checksum Protocol is used to increase security on the RS422/485 link. This protocol enables both your computer and your UDC to detect messages that the RS422/485 link has transmitted inaccurately. Thus, this protocol makes the RS422/485 communications link more reliable.

CAUTION

Failure to use checksum protocol could make the undetected error rate for the RS422/485 link unacceptable for your process control application.

Using checksum protocol

You can use the checksum protocol with any message exchange. The UDC uses the protocol to check the transmission of request messages. Your computer uses the protocol to check the transmission of response messages.

When a message exchange includes checksum protocol:

- Your UDC can tell, with high probability, if the ASCII code in the request message has changed during transmission from your computer.
- Your computer can tell, with high probability, if the ASCII code in the response message has changed during transmission from the UDC.

To use Checksum Protocol, you change the format of the request message as shown in Figure 3-4 as follows:

- You use a 4204 in the request format.
- You insert a 2-digit Hexadecimal number that represents the checksum that you have calculated from the ASCII codes in the request message as explained in “Calculating the Checksum”. See Section 7 for an ASCII Conversion table and a Hexadecimal Binary table.

Figure 3-4 Request Format for Checksum Protocol

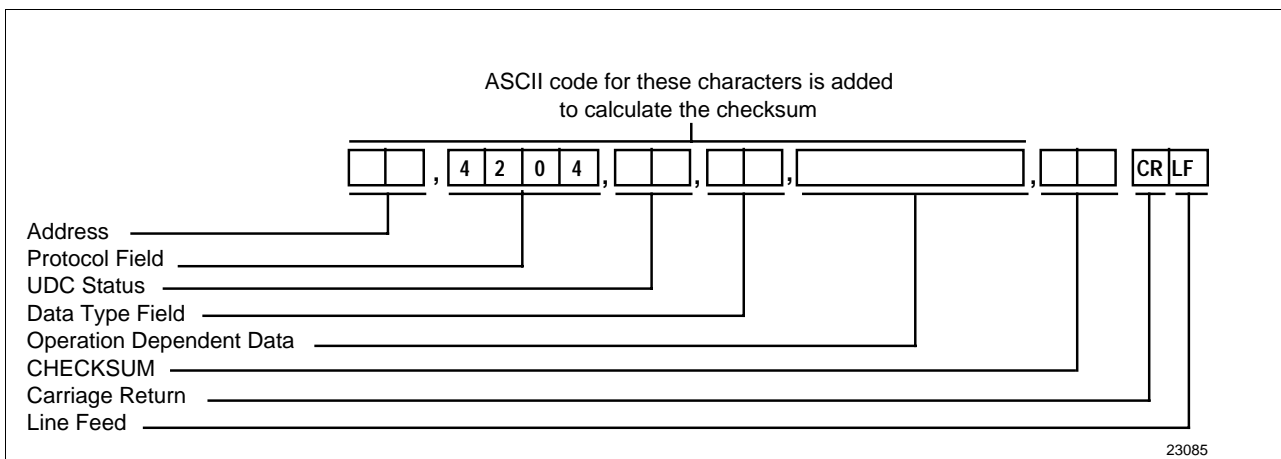

3.7 Checksum Protocol (for Data Security), Continued

Calculating the Checksum

Table 3-8 lists the procedure for calculating the checksum. See Figure 3-5 for an example.

Table 3-8 Calculating the Checksum Procedure

Step	Action
1	Take the binary sum, ignoring carries generated by the most significant bits, of the ASCII code for each of the message's characters, ignoring parity, up to but not including the CHECKSUM field and the CR and LF characters. The final sum should be an 8-bit binary number. See Section 7 for ASCII Conversion table and Hexadecimal to Binary table.
2	Convert the four least significant bits of this sum to the equivalent hexadecimal digit. This becomes the least significant digit in the CHECKSUM field.
3	Convert the four most significant bits of this sum to the equivalent hexadecimal digit. This becomes the most significant digit in the checksum field.

3.7 Checksum Protocol (for Data Security), Continued

Checksum calculation example Figure 3-5 shows an example of the result of a checksum calculation according to instructions in Table 3-8.

Figure 3-5 Example of Checksum Calculation

Example		
03,4204,E4,18,001,7C CR LF		
0	0011	0000
3	0011	0011
	<hr/>	<hr/>
	0110	0011
,	0010	1100
	<hr/>	<hr/>
	1000	1111
4	0011	0100
	<hr/>	<hr/>
	1100	0011
2	0011	0010
	<hr/>	<hr/>
	1111	0101
0	0011	0000
	<hr/>	<hr/>
	0010	0101
4	0011	0100
	<hr/>	<hr/>
	0101	1001
,	0010	1100
	<hr/>	<hr/>
	1000	0101
E	0100	0101
	<hr/>	<hr/>
	1100	1010
4	0011	0100
	<hr/>	<hr/>
	1111	1110
,	0010	1100
	<hr/>	<hr/>
	0010	1010
1	0011	0001
	<hr/>	<hr/>
	0101	1011
8	0010	1000
	<hr/>	<hr/>
	1001	0011
,	0010	1100
	<hr/>	<hr/>
	1011	1111
0	0011	0000
	<hr/>	<hr/>
	1110	1111
0	0011	0000
	<hr/>	<hr/>
	0001	1111
1	0011	0001
	<hr/>	<hr/>
	0101	0000
,	0010	1100
	<hr/>	<hr/>
	0111	1100
Hex →	7	C (Checksum)

23086

3.7 Checksum Protocol (for Data Security), Continued

Success or failure After receiving a request that uses checksum protocol, the UDC calculates the checksum of the characters received and compares this to the hexadecimal number stated in the checksum field. Depending on whether the checksums agree, the UDC returns either the “success” or “failure” response. Figure 3-6 indicates what happens when checksum protocol is used.

Figure 3-6 Using Checksum Protocol

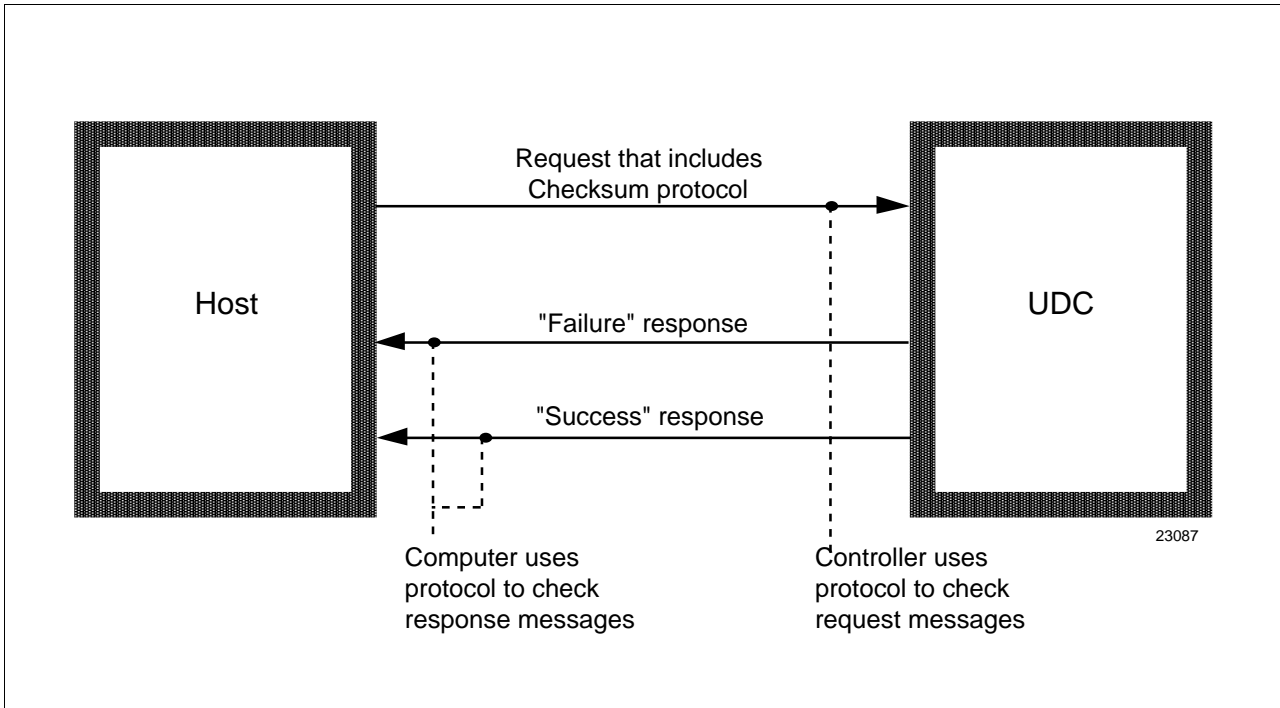

3.7 Checksum Protocol (for Data Security), Continued

Success response If the checksums agree – and no other problems are encountered – the UDC returns the success response beginning with Request Message Status Code 00. Figure 3-7 indicates this response.

Figure 3-7 “Success Response” Message Fields

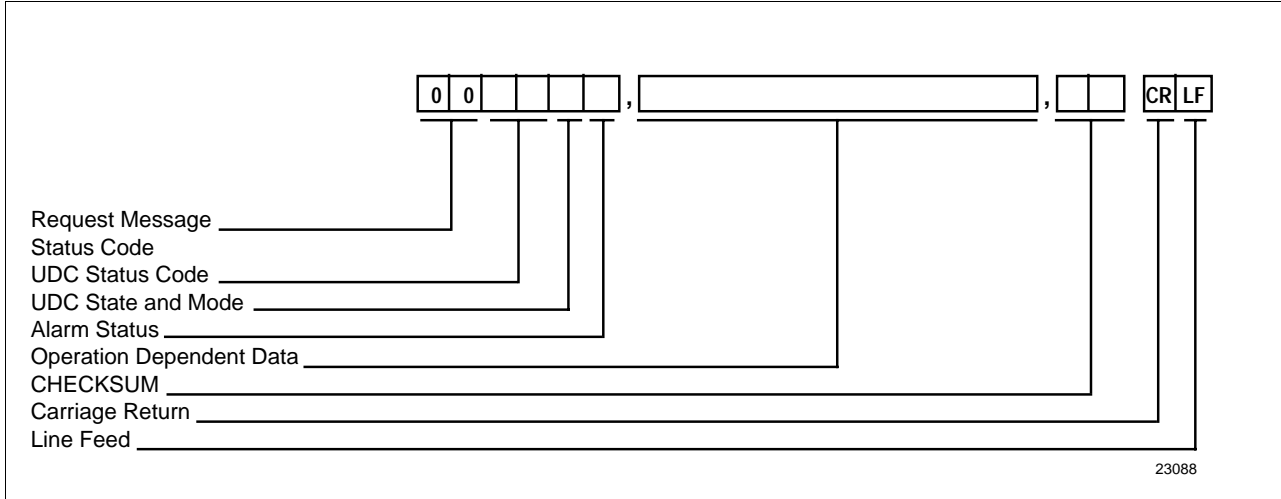

3.7 Checksum Protocol (for Data Security), Continued

Failure response If the checksums disagree, UDC ignores the request and returns the failure response Request Message Status Code 04. To recover, your computer repeats the operation. Figure 3-8 indicates this response.

Figure 3-8 “Failure Response” Message Fields

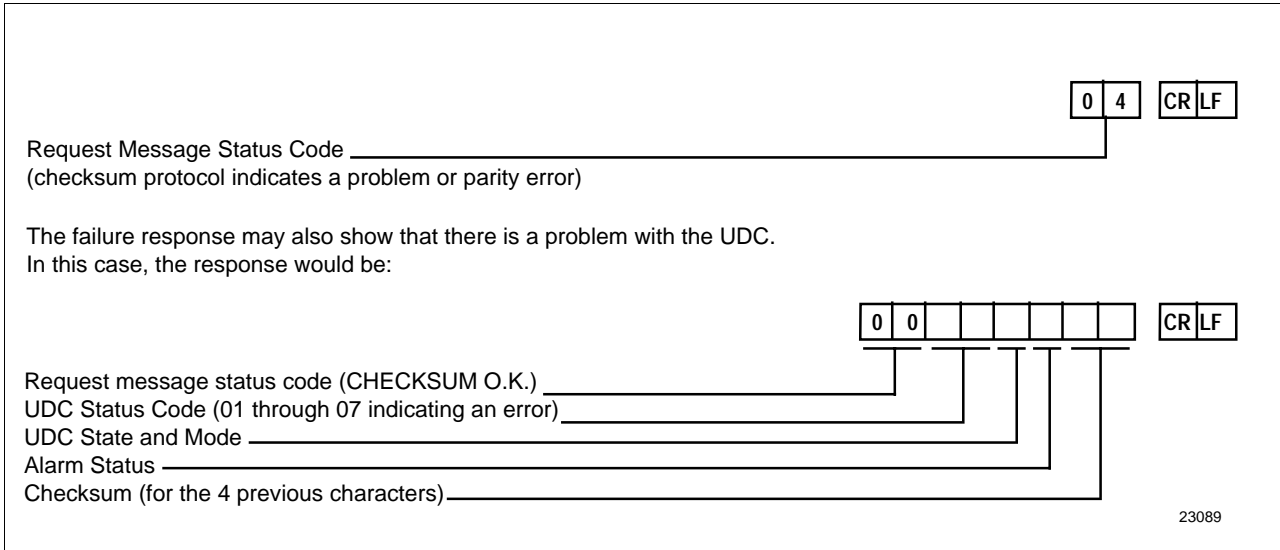

Checksum Calculation After receiving a response that has checksum protocol, your computer should perform the checksum calculations on the characters received, and compare the results to the checksum in the response message. If the checksums disagree, your computer should repeat the operation.

NOTICE

If there is a problem with the UDC itself, a UDC Status Code indicating an error will be returned.

3.8 Shed

What is Shed?

Shed happens when the controller, which has been working in "Slave," reverts to "Stand Alone" mode. Upon receiving a "Slave" message, the controller resets the "SHED TIMER." If this timer expires before the next valid message, the controller goes to stand alone operation. When the host reconnects with a valid message, the response will indicate as 8 at the third digit to indicate a restart after shed.

Thus SHED acts as a safeguard in case the computer or communications link fail. If something prevents the computer from communicating with the controller the device returns to the local control mode. The local operator is then able to regain control over the controller and operate it by the keyboard.

Shed time

Shed Time works like a timer. The number selected will represent how many sample periods there will be before the controller sheds from computer control. You can configure the shed time to be one that is between 1/3 second and approximately 83 seconds. 0 = No Shed.

Shed controller mode and output level

This determines the mode of local control whenever the controller is shed from the communication link.

Shed setpoint recall

This determines what setpoint will be used if the controller is shed from the communications link.

How to enter this information

Refer to "Preparing the Controller for Communications" in this section for these selections and procedure for entering the information into the controller.

3.9 Loopback

Making sure all the UDC2300 controllers are on-line

Once you have established communications between the UDC2300 controller and your computer and understand the message exchange, it is a good idea to test communications to all the controllers on the RS422/485 link. The LOOPBACK operation is an easy way to do this. By including the appropriate address in the loopback operation, you can send a series of characters from your computer to any device on the link.

After receiving these characters, the device addressed "echoes" back the same characters. By comparing the characters sent to those returned, you can tell whether communications are working correctly.

Loopback message exchange

With this message exchange, you can test the communication link between your computer and any controller.

- In the request message, your computer sends a series of characters to the desired device.
- In the response message, the device returns the characters it received to your computer.

Request message

Table 3-9 is an example of the Loopback Request Message with or without the checksum.

Table 3-9 Example of Loopback Request Message

Protocol	Message Format
With Checksum	AA,4204,E8,DD,123456789ABC,CS CR LF (12 characters max.)
Without Checksum	AA,0204,E8,DD,123456789ABCDE, CR LF (14 characters max.) <i>Where:</i> AA = Status Address

3.9 Loopback, Continued

Response message Table 3-10 is an example of the Loopback Response Message with or without the checksum.

Table 3-10 Example of Loopback Response Message

Protocol	Message Format
With Checksum	OOSSMA,123456789ABC,CS CR LF
Without Checksum	OOSSMA,123456789ABCDE, CR LF <i>Where:</i> OO = UDC Type Error SS = UDC Status M = Mode (Hex – see "Message Exchange") A = Alarm Data (Hex – see "Message Exchange")

Programming example

The programming statements in Table 3-11 show how you could perform the LOOPBACK operation with the UDC controller that has station address 09– not using checksum.

If the LOOPBACK operation is successful, these statements would print OOOOMA,HELLO#09.

Where: M = Mode
 A = Alarm Data

Table 3-11 Programming Example

	Programming Statement	Result
Request	10 Write (5,20) 20 Format ("09,0204,E8,DD,HELLO#09")	Sending the LOOPBACK request message that contains the eight characters HELLO#09 to the controller with station address 09.
Response	30 Read (6,40) Reply 40 Format (A15) 50 Write (7,60) Reply 60 Format (A15)	Receiving and printing the response message that contains the characters returned.

3.10 Recovering from Communications Failures

What is a lost message?

When your computer sends a request message but doesn't receive a response, a message (either the request or the response) has been lost on the link. As shown in Figure 3-9, problems in your computer, the link, or the controller could cause a message to get lost.

What happens to a lost message?

Depending on how your programming handles messages, a lost message could hang up your programming forever. Suppose your programming uses a high-level language input command (in Fortran, READ) to retrieve response messages from the input device or buffer fed by the link. Upon executing this input command, your computer goes to the input device to retrieve the response message and waits there until the data arrives. If a message is lost, the message exchange is never completed. Thus, the input command is left waiting for a response message that will never arrive.

As you can see, you must design your programming to handle the possibility that the messages will get lost on the link. Make sure that your programming includes a timing routine that detects the lost message and aborts the pending input command.

Figure 3-9 Lost Messages

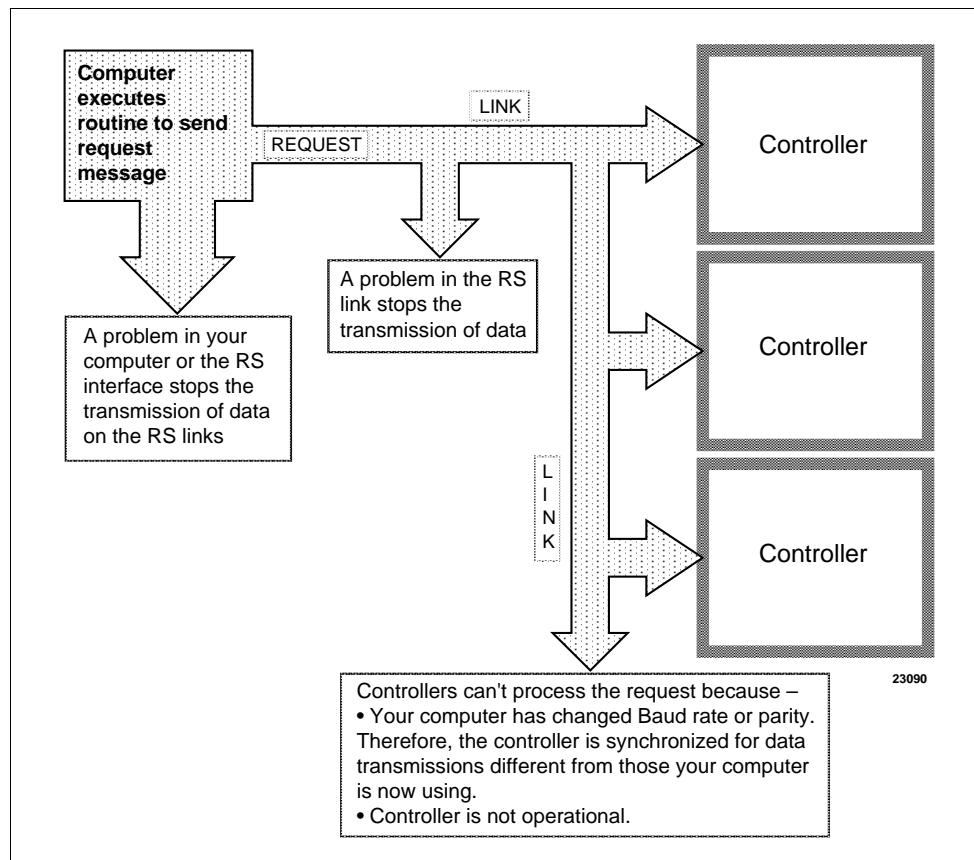

3.10 Recovering from Communications Failures, Continued

Timing message exchanges to detect lost messages

The flowchart in Figure 3-10 shows how to time a message exchange so that you can tell if a message has been lost. (This is only an example, not the suggested method.) Like all timing routines, this one includes a wait and a read interrupt (in Basic, a PEEK) rather than a standard input command.

Figure 3-10 Timing a Message Exchange and Checking for a Response

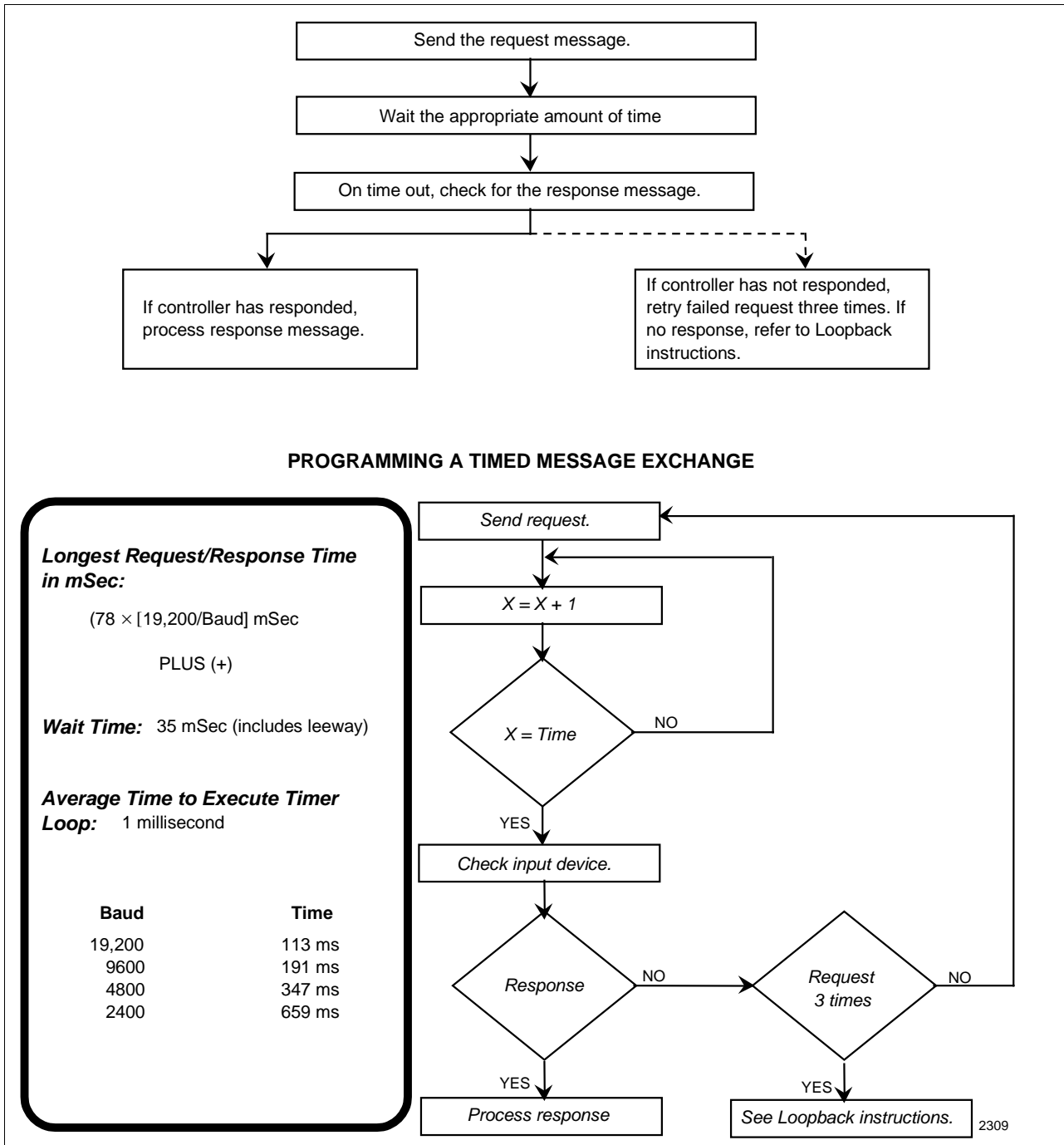

3.10 Recovering from Communications Failures, Continued

- Wait** The WAIT is the amount of time that your computer will wait for a response before assuming that a message has been lost. If the response doesn't appear in the allotted time, your computer should retry the request – up to three times. If your computer still hasn't gotten a response, your programming assumes that communications on the link have failed and calls the recovery or alarm routine.
- Read Interrupt** The READ interrupt merely checks that input device or buffer for data, instead of waiting indefinitely until data arrives.
- How long to wait** Before you can program a timing routine, you must determine how long to wait for a response. This wait must be at least as long as the response time for the longest message exchange when executed at your computer's baud rate. Also note that after the UDC has completed sending a response to your computer, it will require up to 1/3 second of additional processing time before it is ready to accept any new request message. If your computer sends a request to the UDC while it is still busy processing the previous request, it will respond with a BUSY status. Your computer can handle this situation by re-trying the request.
- Timing routine** Once you have established the appropriate wait time, you can program the timing routine. To do so, you loop an instruction until the desired wait time has elapsed, as shown in the figure on the previous page.
- This timing routine is the simplest one you could program. But, it is not efficient – your program waits the same amount of time for the shortest message as the longest. You devise a more efficient routine, such as a loop that checks for the response message each time "X" increments.

Section 4 – Read and Write Operations

4.1 Read Operations

Introduction

The Read operations (Data Retrieval) allow your computer to read data from any controller on the RS422/485 link. Data retrieval for each operation is accomplished through a message exchange between your computer and the device you are addressing.

You can request the data for only one identifying code at a time, but the response may be a single variable or a three variable type depending on the code used.

Transaction states

Read transactions can be performed in either UDC state: Monitor or Slave.

NOTICE

Any change made in UDC state or control mode will not be indicated in the response until the next transaction.

Analog or digital

The parameters being read will be either Analog (codes 1 through 125) or Digital (codes 128 through 255) value or selections so that all Read message formats must adhere to the standardization rules shown in the tables that follow.

4.2 Read Analog Parameters

Introduction The Analog identifying codes are codes 001 through 125. Each of these codes is read using the Request and Response formats shown in tables 4-1 and 4-2.

Request format Table 4-1 lists the request format with or without checksum, for Analog I.D. codes 001 through 125.

Where:

- AA = Station Address
- X = UDC State and Mode (Hex – see "Message Exchange")
- NNN = Identifying Code for Analog Parameter (001 to 125)
- CS = Checksum Value (2 digit hex – see "Checksum")
- CR = Carriage Return
- LF = Line Feed

Table 4-1 Analog Parameter Request Format

Format Type	Format
With Checksum	AA, 4204, X4, NNN, 0, CS CR LF
Without Checksum	AA, 0204, X4, NNN, 0, CR LF

4.2 Read Analog Parameters, Continued

Response format Table 4-2 lists the response format, single or three variables with or without checksum, for Analog I.D. codes 1 through 125.

Where:

- OO = UDC Type Error (00 = No Error)
- SS = UDC Status
- M = Mode (Hex – see "Message Exchange")
- A = Alarm Data (Hex – see "Message Exchange")
- NNN = Identifying Code for Analog Parameter
- DDD.D = Floating Point Value
- CS = Checksum (two digit hex – see "Checksum")
- CR = Carriage Return
- LF = Line Feed

Table 4-2 Analog Parameter Response Format

Variable	Format Type	Format
Single	with checksum	OOSSMA, NNN, DDD.D, CS, CR LF (see note 1)
	without checksum	OOSSMA, NNN, DDD.D, CR LF (see note 1)
Three	with checksum	OOSSMA, NNN, DDD.D, DDDD, DDD.D, CS, CR LF (see note 1)
	without checksum	OOSSMA, NNN, DDD.D, DDD.D, DDDD.,CR LF (see note 1)

Note 1. Floating point values may look like this:

```

DDDD.    DDD.D    DD.DD    D.DDD
-DDD.D   -DDD.    -DD.DD   -D.DDD
  
```

They must have four characters and one decimal point as shown, negative sign as an extra character.

4.2 Read Analog Parameters, Continued

Example Figure 4-1 is an example of a Read Analog Parameter message exchange; specifically, Read the value of heat gain; Analog I.D. code 001.

Figure 4-1 Read Analog Parameter Message Exchange

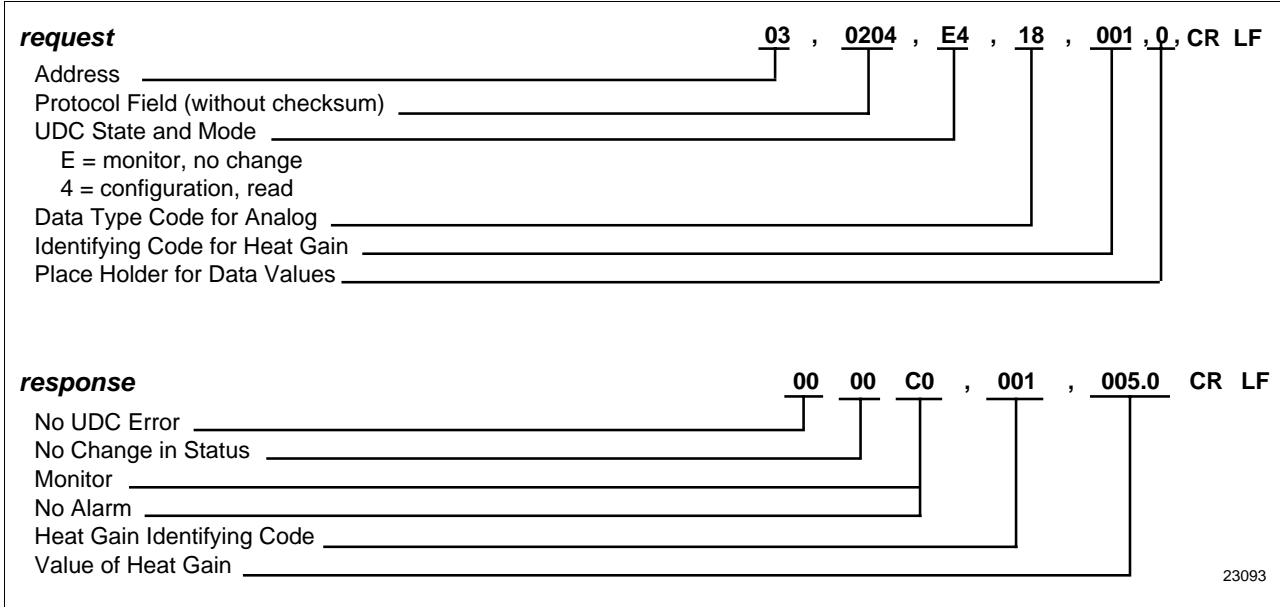

4.3 Read Digital Parameters

Introduction The Digital identifying codes are codes 128 through 255. Each of these codes is read using the Request and Response formats shown in Tables 4-3 and 4-4.

Request format Table 4-3 lists the request format, with or without checksum, for digital I.D. codes 128 through 255.

Where:

- AA = Station Address
- X = UDC State and Mode (Hex – see "Message Exchange")
- MMM = Identifying Code for Digital Parameter (128 to 255)
- CS = Checksum Value (two digit hex – see "Checksum")
- CR = Carriage Return
- LF = Line Feed

Table 4-3 Digital Parameter Request Format

Format Type	Format
With Checksum	AA, 4204, X4, MMM, 0, CS, CR LF
Without Checksum	AA, 0204, X4, MMM, 0, CR LF

4.3 Read Digital Parameters, Continued

Response format Table 4-4 lists the response format, with or without checksum, for digital I.D. codes 128 through 255.

Where:

- OO = UDC Type Error (00 = No Error)
- SS = UDC Status
- M = Mode (Hex – see "Message Exchange")
- A = Alarm Data (Hex – see "Message Exchange")
- MMM = Identifying Code for Digital Parameter
- DDD = Digital Value (always 3 characters)
- CS = Checksum (2 digit hex – see "Checksum")
- CR = Carriage Return
- LF = Line Feed

Table 4-4 Digital Parameter Response Format

Format Type	Format
With Checksum	OOSSMA, MMM, DDD, CS CR LF
Without Checksum	OOSSMA, MMM, DDD, CR LF

Example Figure 4-2 is an example of a Read Digital Parameter message exchange; specifically, read the algorithm selection: digital I.D. code 128 and maintain or change the UDC state to slave.

Figure 4-2 Read Digital Parameter Message Exchange

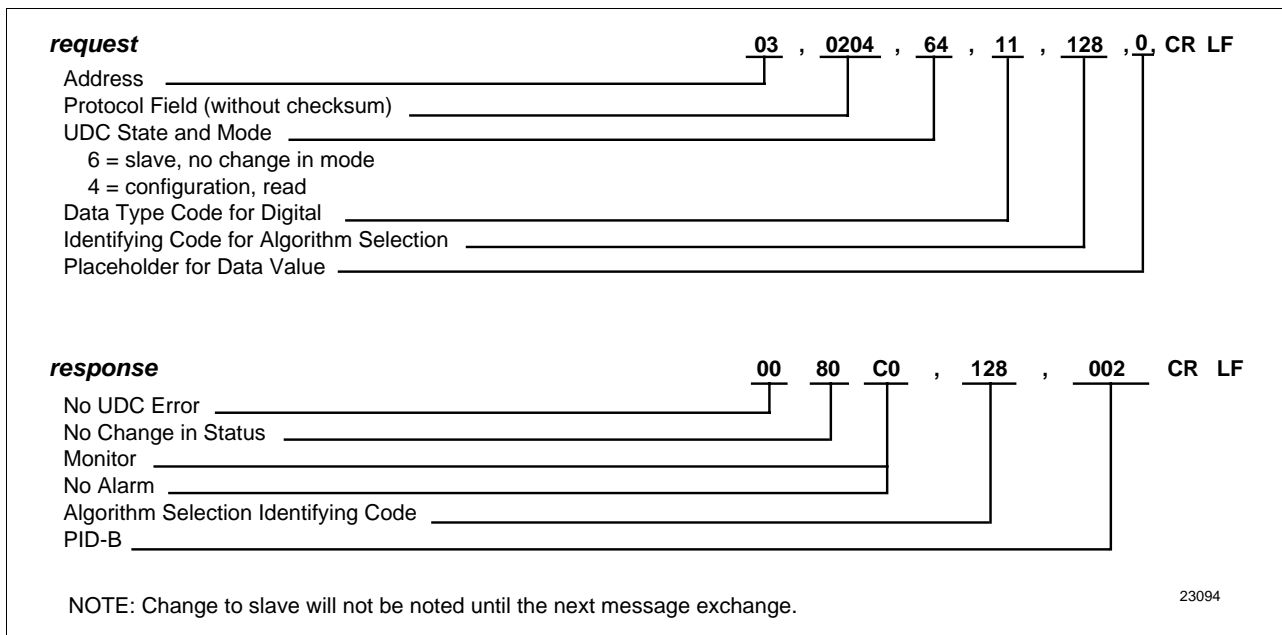

4.4 Write Operations

Introduction The Write operations allow your computer to write data type transactions such as Overriding the PV, Setpoint, inputs as well as writing configuration data such as Tuning Parameters, Algorithm Selection, Setpoint Ramp Information, etc. to the controller.

Transaction state Write transactions can only be performed in the Slave Mode.

Write message exchange In a Write transaction, only single items are permitted to be written.

A Ready transaction is required to determine if the information was received.

Following any Write, a Busy indication is returned.

Table 4-5 lists the steps for the Write message exchange.

Table 4-5 Write Message Exchange Steps

Step	Action
1	Do a Write request to change a parameter (see Table 4- 6).
2	Receive a Busy response (see Table 4-7).
3	Send Ready request to see if the information has been processed (see Table 4-8).
4	Receive an "Is Ready" response (see Table 4-9).
5	Do a Read request to check the value (OPTIONAL).

CAUTION

The data stored in non-volatile memory is expected to be retained for 10 years. However, additional writes will degrade the retentivity of the non-volatile memory.

NOTICE

Any change made in UDC State or Control Mode will not be indicated in the response until the next transaction.

4.5 Write Analog Parameters

Introduction The analog identifying codes are codes 001 through 125. The Write request and response formats are shown in Tables 4-6, 4-7, 4-8, and 4-9.

Request format Table 4-6 lists the write request format with or without checksum for Analog I.D. codes 1 through 125.

Where:

- AA = Station Address
- X = UDC State and Mode (Hex – see "Message Exchange")
- NNN = Identifying Code for Analog Parameter (001 to 125)
- DDD.D = Floating Point Value (see note 1)
- CS = Checksum Value (two digit hex – see "Checksum")
- CR = Carriage Return
- LF = Line Feed

Table 4-6 Write Request Format for Analog I.D. Codes

Format Type	Format
With Checksum	AA, 4204, X5, NNN, DDD.D, CS CR LF (see note 1)
Without Checksum	AA 0204, X5, NNN, DDD.D, CR LF (see note 1)

Note 1 Floating point values may look like this:

DDDD.	DDD.D	DD.DD	D.DDD
-DDD.D	-DDD.	-DD.DD	-D.DDD

They must have four characters and one decimal point as shown, negative sign as an extra character.

4.5 Write Analog Parameters, Continued

“Busy” response

If the controller did not process the information, the controller will return a four-digit status code indicating an error in the third and fourth digit. See “Status Codes.”

Table 4-7 lists the busy response that can be received, with or without checksum, after a Write request that indicates a good write:

Where:

- M = Mode (Hex - see “Message Exchange”)
- A = Alarm Data (Hex – see "Message Exchange")
- CS = Checksum (two digit hex – see "Checksum")
- CR = Carriage Return
- LF = Line Feed

Table 4-7 “Busy” Response

Format Type	Format
With Checksum	0002MA, CS, CR LF
Without Checksum	0002MA, CR LF

“Ready” request

After receiving a “Busy” response, enter a “Ready” request. Table 4-8 lists the “Ready” request format, with or without checksum.

Table 4-8 Ready Requests

Format Type	Format
With Checksum	03, 4204, 66, 11, 0, CS CR LF
Without Checksum	03, 0204, 66, 11, 0, CR LF

4.5 Write Analog Parameters, Continued

“Is Ready” response This is the response to a Ready request. Table 4-9 lists the “Is Ready” response formats, with or without checksum.

Where:

- SS = UDC Status
- M = Mode (Hex - see “Message Exchange”)
- A = Alarm Data (Hex – see "Message Exchange")
- CS = Checksum (two digit hex – see "Checksum")
- CR = Carriage Return
- LF = Line Feed

Table 4-9 “Is Ready” Response

Format Type	Format
With Checksum	00SSMA, CS, CR LF
Without Checksum	00SSMA, CR LF

Check write transaction

To check the value a change do a “Read” for the particular parameter (I.D. Code) you have changed.

4.5 Write Analog Parameters, Continued

Example Figure 4-3 is an example of a Write of an analog parameters message exchange; specifically to change the gain value from 5 to 10; analog I.D. code 001.

Figure 4-3 Write Analog Parameter Message Exchange Example

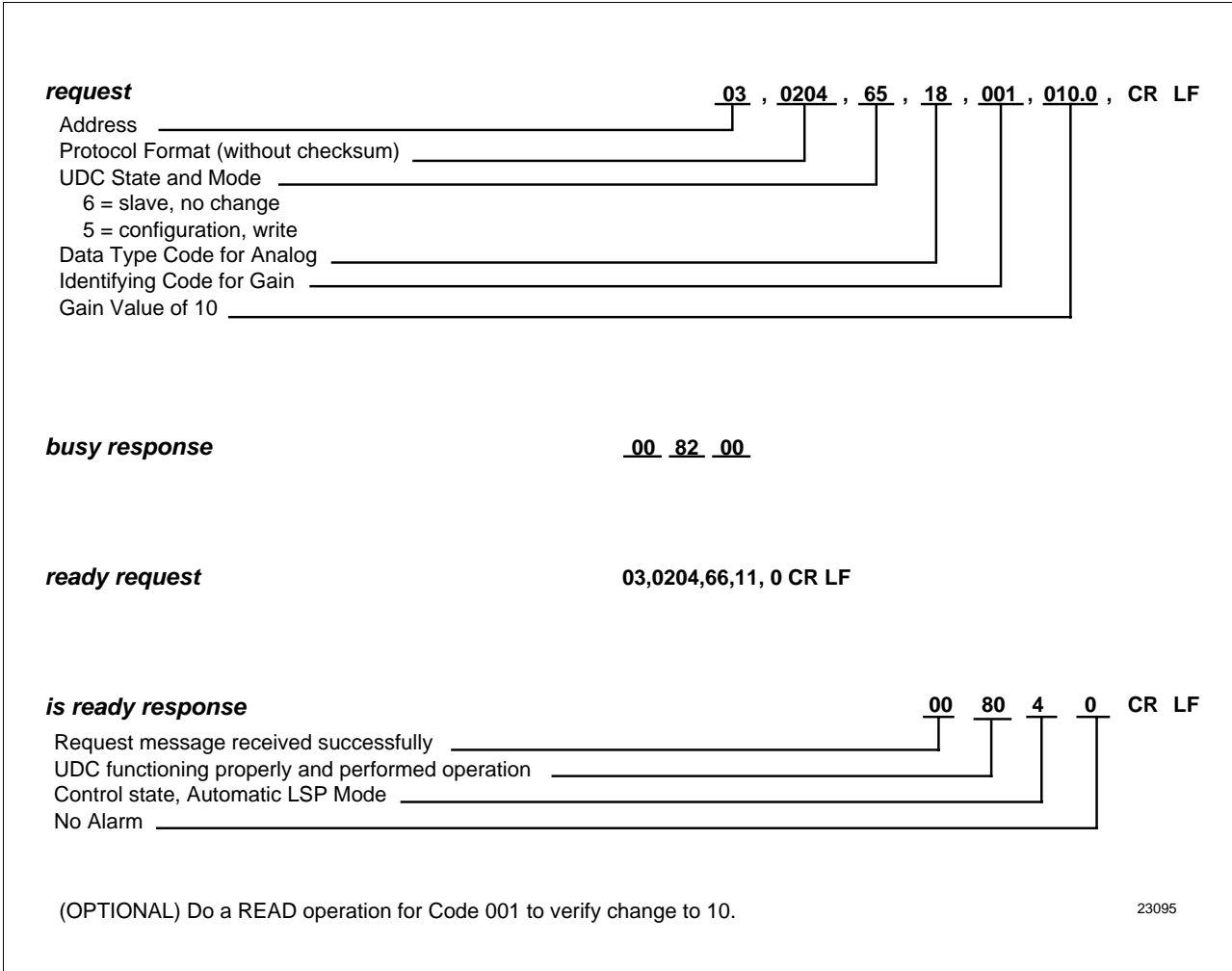

4.6 Write Digital Parameters

Introduction The digital identifying codes are codes 128 through 225. The Write request and response formats are shown in Tables 4-10, 4-11, 4-12, and 4-13.

Request format Table 4-10 lists the Write request format, with or without checksum, for digital I.D. codes 128 through 255.

Where:

- AA = Station Address
- X = UDC State and Mode (Hex – see "Message Exchange")
- MMM = Identifying Code for Digital Parameter (128 to 255)
- DDD = Digital Value (always three characters)
- CS = Checksum Value (two digit hex – see "Checksum")
- CR = Carriage Return
- LF = Line Feed

Table 4-10 Write Request Format for Digital I.D. Codes

Format Type	Format
With Checksum	AA, 4204, X5, MMM, DDD, CS CR LF
Without Checksum	AA, 0204, X5, MMM, DDD, CR LF

“Busy” response If the controller did not process the information, the controller will return a four-digit status code, indicating an error in the third and fourth digit. See “Status Codes.”

Table 4-11 lists the busy responses that can be received with or without checksum, after a write request that indicates a good write:

Where:

- M = Mode (Hex - see “Message Exchange”)
- A = Alarm Data (Hex – see "Message Exchange")
- CS = Checksum Value (2 digit hex – see "Checksum")
- CR = Carriage Return
- LF = Line Feed

4.6 Write Digital Parameters, Continued

“Busy” response, continued

Table 4-11 Busy Response

Format Type	Format
With Checksum	0002MA, CS, CR LF
Without Checksum	0002MA, CR LF

“Ready” request

After receiving a “Busy” response, enter a “Ready” request. Table 4-12 lists the “Ready” request format, with or without checksum.

Table 4-12 Ready Request

Format Type	Format
With Checksum	03, 4204, 66, 11, 0 CS CR LF
Without Checksum	03, 0204, 66, 11, 0 CR LF

“Is Ready” response

This is the response to the Ready request. Table 4-13 lists the “Is Ready” response formats, with or without checksum.

Where:

- SS = UDC Status
- M = Mode (Hex - see “Message Exchange”)
- A = Alarm Data (Hex – see "Message Exchange")
- CS = Checksum Value (two digit hex – see "Checksum")
- CR = Carriage Return
- LF = Line Feed

Table 4-13 “Is Ready” Response

Format Type	Format
With Checksum	00SSMA, CS, CR LF
Without Checksum	00SSMA, CR LF

Check write transaction

To check the value of a change, do a “Read” for the particular (I.D. Code) you have changed.

Section 5 – Read, Write and Override Parameters on UDC2300 Process Controllers

5.1 Overview

Introduction

This section contains information concerning Reading, Writing, and Overriding parameters on the UDC2300 Process Controller. There are two types of parameters:

- Data Transfer—these parameters include reading control data, option status, and reading or changing setpoints or output.
- Configuration Data—all the configuration data is listed in the order in which it appears in the controller.

Each type of parameter has the identifying codes listed with it. Follow the message exchange rules listed in “Read and Write Operations.”

What’s in this section

This section contains the following topics:

Topic	See Page
5.1 Overview	53
5.2 Reading Control Data	55
5.3 Read Option Status	56
5.4 Miscellaneous Read Only’s	57
5.5 Setpoints	59
5.6 Using a Computer Setpoint	60
5.7 PV or Setpoint Override	62
5.8 Reading or Changing the Output	63
5.9 Local Setpoint/PID Set Selection and Setpoint Ramp Status	64
5.10 Configuration Parameters Setup Groups	67
Timing	68
Tuning	68
SP Ramp/SP Rate/SP Program	70
Accutune	72
Algorithm	73
Input 1	74
Input 2	78
Control	80
Communications	82
Alarms	83

5.1 Overview - UDC2300, Continued

General information

Analog Parameters

- Whenever analog parameters 001 through 114 (those that can be changed via communications) are changed, a Write cycle occurs immediately after receipt of the message.

Override Parameters

- Override analog parameters 120, 123 and 125 (PV, output, computer setpoint) are not stored in non-volatile memory and can be changed as frequently as desired with no effect on non-volatile memory retentivity, but controller must remain in slave mode.

Digital Parameters

- Whenever digital configuration parameters 128 through 250 are updated via communications, the non-volatile memory is updated as soon as the message is received.

5.2 Reading Control Data - UDC2300

Overview You can Read the following control data from the UDC controller.

- Input 1
- Input 2
- PV
- Internal RV
- PV, Setpoint, Output

I.D. codes Use the identifying codes listed in Table 5-1 to read the specific items.

A Write request for these codes will result in an Error message.

Table 5-1 Control Data Parameters

Parameter Description	Identifying Code	Format Code	Range or Selection
Input #1	118	18	In Engineering Units or Percentage
Input #2	119	18	In Engineering Units or Percentage
PV	120	18	In Engineering Units or Percentage
Internal RV	121	18	In Engineering Units or Percentage
PV, Setpoint, and Output*	122	18	In Engineering Units or Percentage

*This Read request will give a three variable response (see Read/Write operation).

5.3 Read Options Status - UDC2300

Read

Doing a read of I.D. code 185 listed in Table 5-2 will tell you which of the available options are enabled/installed or disabled/not installed.

Table 5-2 Option Status

Parameter Description	Identifying Code	Format Code	Range or Selection
Option Status (Read only)	185	11	See Figure 5-1

The data field in the response message will be a decimal number from 0 to 255. Convert the decimal number to binary as shown in Figure 5-1 to determine which options are or are not active.

Figure 5-1 Option Status Information

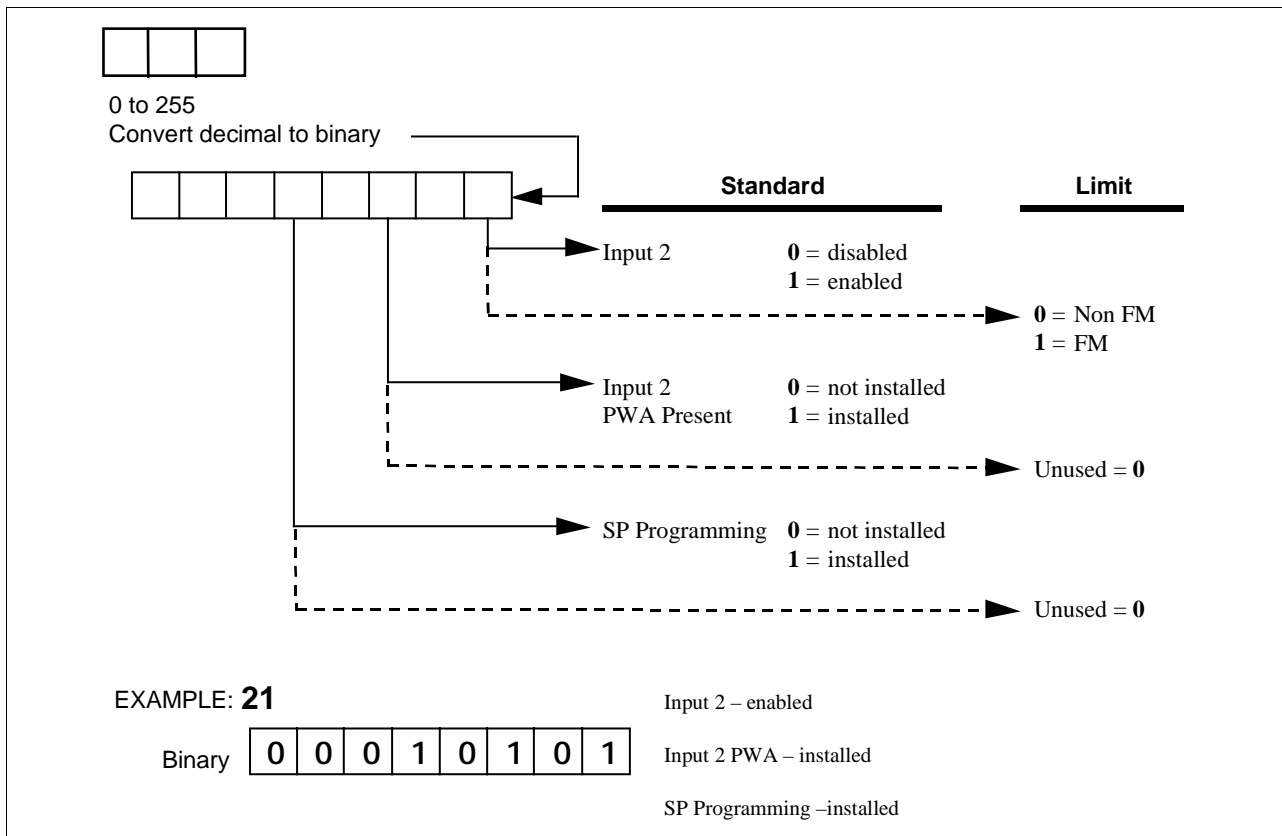

5.4 Miscellaneous Read Only's - UDC2300

I.D. codes for Read Only's The identifying codes listed in Table 5-3 represent some information that are Read only. No Writes allowed.

Table 5-3 Miscellaneous Read Only's

Parameter Description	Identifying Code	Format Code	Range or Selection
Software Type	157	11	READ only (UDC2300) A1 = Basic UDC2300 software A2 = Limit Controller
Software Version	167	11	READ only 0 to 255
UDC Error Status (Definitions are listed in Table 5-4)	255	11	See below READ/WRITE* 001 = Emergency Manual 002 = Failsafe 004 = Working Calibration Checksum Error 008 = Configuration Checksum Error 016 = Factory Calibration Error 032 = Hardware Failure 064 = Restart after Shed 128 = Configuration/Calibration Memory Changed

* Write to clear.

For example:

If Read returns 192 (restart after shed-64 plus configuration change-128)

Write anything to I.D. code 255

Read returns 000 (clear).

5.4 Miscellaneous Read Only's - UDC2300, Continued

Error status definitions

Table 5-4 lists the UDC error status codes and their definitions.

Table 5-4 Error Status Definitions

Code	Error	Definitions
001	Emergency Manual	Indicates that the output of the unit which has been in slave operations, is under manual control, locally. Error remains until local control is relinquished at the controller.
002	Failsafe	Error occurs whenever the control reverts to failsafe operation and remains as long as the condition exists.
004	Working Calibration Checksum Error	Indicates that an error exists in the working calibration data. Re-select the inputs to load factory calibration data or field calibrate the inputs.
008	Configuration Checksum Error	Error exists in the configuration data. Verify configuration data at the keyboard. Checksum will be recomputed by stepping the controller through the status tests.
016	Factory Calibration Error	Error exists in the factory calibration data and remains as long as the condition exists.
032	Hardware Failure	Indicates either a RAM tests failure or Input 1, Input 2, Input 3 failure on two consecutive conversions.
064	Restart After Shed	Error occurs whenever a shed of slave override is performed. Error is reset following a WRITE command to I.D. code 255 (064).
128	Configuration /Calibration Memory Changed	Error occurs whenever shed, configuration, or calibration changed. Also occurs whenever there is a change of state in 001, 002, 004, 008, or 016. Error is reset following a Write command to I.D. code 255.

5.5 Setpoints - UDC2300

Overview You can use two separate local setpoints in the UDC Controller. The identifying codes listed Table 5-5 allow you to select which setpoint you want to use and to enter a value in Engineering Units or Percent (whichever is selected at code 161) for that setpoint via communications.

I.D. codes Make your selection using I.D. code 173 and enter the value for the setpoint chosen using ID code 39 (SP1) or 53 (SP2).

Table 5-5 Setpoint Code Selections

Parameter Description	Identifying Code	Format Code	Range or Selection
Local Setpoint #1	039	18	Value within the setpoint range limits
Local Setpoint #2	053	18	Value within the setpoint range limits
Number of Local Setpoints	173	11	000 = Local Setpoint #1 only 001 = 2nd Local Setpoint via keyboard or communications

Associated parameters Refer to Table 5-6 to display or change any of the parameters associated with the setpoint.

Table 5-6 Setpoint Associated Parameters

Parameter	Code
Setpoint Limits	007, 008
Computer Setpoint	125

5.6 Using a Computer Setpoint (Overriding Controller Setpoint) - UDC2300

Overview You can use a setpoint generated from the computer to override the setpoint being used by the controller.

The value generated by the computer will have ratio and bias applied by the controller.

I.D. codes Use the Identifying Code in Table 5-7 to enter the computer setpoint.

Table 5-7 Computer Setpoint Selection

Parameter Description	Identifying Code	Format Code	Range or Selection
Computer Setpoint	125	18	Value from computer with Ratio/Bias applied by the controller. Within the Setpoint Range Limits in Engineering Units or Percent.

Shed The computer setpoint override will continue until "SHED" from communications occurs or the controller is placed into monitor mode through communications. Doing periodic "SLAVE READS" within the shed time will allow the override to continue until communication is stopped and shed time elapses.

NOTICE

0 Shed (code 154) allows the override to continue indefinitely or until the override is canceled. (See override selection ID code 183.)

When SP is overridden, the upper display will flash "CSP" (provided the SP Programmer is not enabled) and the lower display will show "CSXXXX."

5.6 Using a Computer Setpoint (Overriding Controller Setpoint) - UDC2300, Continued

Associated parameters

Refer to Table 5-8 for the codes to display or change any of the parameters associated with the computer setpoint.

Table 5-8 Computer Setpoint Associated Parameters

Parameter	Code
Setpoint Limits	007, 008
Local Setpoint #1	039
Local Setpoint #2	053
Local Setpoint Selection	173
Computer Setpoint Ratio	021
Computer Setpoint Bias	022

5.7 PV or Setpoint Override Selections - UDC2300

Overview You can **Read** the present override status of the PV or setpoint or you can do a **Write** transaction to cancel the override.

I.D. codes Use the Identifying Code in Table 5-9 to Read or Write your selection.

Table 5-9 PV or Setpoint Override Selections

Parameter Description	Identifying Code	Format Code	Range or Selection
PV or Setpoint Override Selection	183	11	01 = Input 1 02 = Input 2 04 = PV 08 = Setpoint Limit Controller <i>(Read Only):</i> 0 = Unlatched 1 = Latched Relay

5.8 Reading or Changing the Output - UDC2300

Overview You can read the output of a particular UDC controller (Read transaction) or you can change it to suit your needs. (Do a Write transaction.)

I.D. codes Use the identifying code in Table 5-10 to monitor (Read) or change (Write) the output (in manual only).

NOTICE

To Write (change) the output, the controller must first be in manual mode.

Table 5-10 Reading or Changing the Output

Parameter Description	Identifying Code	Format Code	Range or Selection
Output	123	18	-5 % to +105 % of full span (current output) 0 % to 100 % (relay type output)

Associated parameters Refer to Table 5-11 for the codes required to display or change any of the parameters associated with the output.

Table 5-11 Associated Output Codes

Parameter	Code
Output Limits	014, 015
Failsafe Output Values	040
Output Deadband	018
Output Hysteresis	019
Output Type	160

5.9 Local Setpoint/PID Selection/Setpoint Ramp Status – UDC2300

Overview

Identifying code 250 lets you monitor or make selections for:

- Tuning Parameter Set #1 or #2
If Tuning Sets selection is “two keyboard” code 172 = 001
- Local Setpoint #1 or #2
If “2 Local Setpoints” is selected 131 = 0, 173 = 1
- Run or Hold Setpoint Ramp or a Setpoint Program Data
If SP Ramp or SP Program is enabled 178 = 1 Program, 178 = 2 Ramp

Read

Table 5-12 is a table of numbers that could be returned by the UDC2300 controller. When a Read is requested for this I.D. code (250) you can determine which parameters are active from this table.

Write

To Write information to the controller, select what parameters you want from Table 5-12 and enter the associated number in the data field of the Write request.

For example:

Suppose you want to change from TUNING SET #1 to TUNING SET #2 while maintaining LOCAL SETPOINT #1 and SP RAMP STATUS = HOLD.

READ 250 response is 00 or 02

WRITE 250 (07)

READ 250 response is 018

Note: Some of the numbers are Read only.

Table 5-12 LSP/PID Set Selection and Setpoint Ramp Status

Parameter Description	Identifying Code	Format Code	Range or Selection
Enhanced Function	250	11	See Figure 5-2

5.9 Local Setpoint/PID Selection/Setpoint Ramp Status - UDC2300, Continued

Read, continued

Figure 5-2 I.D. Code 250 Indications

Tuning Set #2 Selection Local Setpoint #2 Selection				
Tuning Set #2 Selection Local Setpoint #1 Selection				
Tuning Set #1 Selection Local Setpoint #2 Selection				
Tuning Set #1 Selection Local Setpoint #1 Selection				
Setpoint Ramp or Program Data Selections				
SP Ramp, Enabled Not in Progress	00	08	16	24
SP Ramp in Progress, Hold	02	10	18	26
SP Ramp in Progress, Run	03	11	19	27
SP Program, Enabled Not in Progress, (READ)	04	12	20	28
SP Program in Progress, Hold (READ/WRITE)	06	14	22	30
SP Program in Progress, Run (READ/WRITE)	07	15	23	31

5.9 Local Setpoint/PID Selection /Setpoint Ramp Status - UDC2300, Continued

Write

A write of code 250 lets you change the SP ramp status as well as the local setpoint or tuning set selection. Refer to Table 5-13.

Table 5-13 I.D. Code 250 Writes

Parameter Description	Identifying Code	Format Code	Range or Selection
Write Local Setpoint/PID Set Selection and SP Ramp Status	250	11	000 = Abort SP Ramp 001 = Run SP Ramp 002 = Hold SP Ramp 003 = Start SP Ramp 004 = Change to Local Setpoint #1 005 = Change to Local Setpoint #2 006 = Change to PID Tuning Set #1 007 = Change to PID Tuning Set #2

NOTICE

To enable or disable the setpoint ramp, refer to Identifying code 150.

5.10 Configuration Parameters - UDC2300

Overview

Listed on the next pages are the identifying codes for the parameters in the various Setup Groups in the UDC2300 Process Controller. The table below lists the Setup Groups and their table numbers in which they are listed. Most of the parameters are configurable through the hosts. Some are Read Only and are indicated as such and cannot be changed.

Setup Group	Table Number
TIMER	5-14
TUNING	5-15
SP RAMP / RATE / PROGRAM	5-16
ADAPTIVE	5-17
ALGORITHM	5-18
INPUT 1	5-19
INPUT 2	5-20
CONTROL	5-21
COMMUNICATIONS	5-22
ALARMS	5-23

Reading or writing

Do a Read or Write (see “Read/Write Operations”), depending on your requirements, using the identifying code and format code listed in the tables. The range or selection available for each range is listed in the tables.

5.10 Configuration Parameters - UDC2300, Continued

Timer

Table 5-14 lists all the I.D. codes and ranges or selections for the function parameters in the Setup Group “TUNING”.

Table 5-14 Setup Group – Timer

Parameter Description	Identifying Code	Format Code	Range or Selection
Timer	216	11	0 = Disable 1 = Enable
Period	099	18	0.00 to 99.59
Start (Initiation)	217	11	0 = Key (Run/Hold Key) 1 = Alarm 2
LDISP (Selection)	218	11	0 = TI REM 1 = Elapsed Time
Timer Reset	214	11	0 = Key (Run/Hold Key) 1 = ALI (Alarm 1 or Key)
Timer Increment	215	11	0 = min (Counts hr/min) 1 = sec (counts min/sec)

Tuning

Table 5-15 lists all the I.D. codes and ranges or selections for the function parameters in the Setup Group “TUNING”.

Table 5-15 Setup Group – Tuning

Parameter Description	Identifying Code	Format Code	Range or Selection
Gain #1 or PB Note 1	001	18	0.01 to 1000 Gain 0.1 to 9999 PB
Rate #1 Note 1	002	18	0.00 to 10.00
Reset #1 Note 1	003	18	0.02 to 50.00
Manual Reset	013	18	-100 to +100
Gain #2 or PB Note 1	004	18	0.01 to 1000
Rate #2 Note 1	005	18	0.00 to 10.00
Reset #2 Note 1	006	18	0.02 to 50.00
Cycle Time #1	158	11	1 to 120 seconds
Cycle Time #2	159	11	1 to 120 seconds

5.10 Configuration Parameters - UDC2300, Continued

Parameter Description	Identifying Code	Format Code	Range or Selection
<p>Lockout (keyboard only)</p> <p>Changes to data always possible via communications regardless of this configuration.</p>	132	11	<p>0 = No Lockout</p> <p>1 = Calibration Locked Out</p> <p>2 = Timer, Tuning, SP Ramp, Accutune or Read/Write</p> <p>3 = Tuning and SP Ramp are read/write, no other parameters are available</p> <p>4 = Maximum Lockout</p>
Keyboard Lockout	191	11	<p>0 = All keys enabled</p> <p>1 = Manual Auto Key Locked</p> <p>2 = Setpoint Select Key Locked</p> <p>3 = Manual/Auto and Setpoint Select Keys Locked</p> <p>4 = Run Hold Key Locked</p> <p>5 = Run Hold Key and Manual/Auto Keys Locked</p> <p>6 = Run Hold Key and Setpoint Select Keys Locked</p> <p>7 = Run Hold, Setpoint Select, and Manual/Auto Keys Locked</p> <p>8 = Autotune Key Locked</p> <p>9 = Autotune and Man/Auto Keys Locked</p> <p>10= Autotune and Setpoint Select Keys Locked</p> <p>11= Autotune , Setpoint Select, and Man/Auto Keys Locked</p> <p>12= Autotune and Run/Hold Keys Locked</p> <p>13= Autotune, Run/Hold, and Man/Auto Keys Locked</p> <p>14= Autotune, Run/Hold, and Setpoint Select Keys Locked</p> <p>15= Autotune, Run/Hold, Setpoint Select, and Man/Auto Keys Locked</p>

NOTE 1: Writes to these locations not available when Accutune is enabled.

5.10 Configuration Parameters - UDC2300, Continued

SP ramp/rate/program Table 5-16 lists all the I.D. codes and ranges or selections for the function parameters in setup group “SP RAMP/RATE/PROGRAM.”

Table 5-16 Setup Group – Setpoint Ramp/Rate Program

Parameter Description	Identifying Code	Format Code	Range or Selection
Setpoint Ramp/Rate Program Selection	178	11	0 = SP Program, Rate, and Ramp Disabled 1 = SP Program Enabled 2 = SP Ramp Enabled 3 = SP Rate Enabled
SP Ramp	150	11	0 = OFF 2 = Ramp
Single SP Ramp Time	174	11	0 to 255 (minutes)
Ramp Final Setpoint	026	18	0 to 9999
SP Rate			
Rate Up (EU/HR)	108	18	0 to 9999
Rate Down (EU/HR)	109	18	0 to 9999
SP Program			
Start Segment Number	175	11	1 to 11
End Segment Number (Soak)	176	11	2, 4, 6, 8, 10, or 12
Engineering Units or Ramp Segments	182	11	0 = HRS:MIN 1 = Degrees/Minute
Program Recycles	177	11	0 to 99
Guaranteed Soak Deviation	087	18	0 to 99.9 (0 = no soak)
Program End State	181	11	0 = Disable SP Program 1 = Hold at Program End
Controller Status at Program End	180	11	0 = Last Setpoint and Mode 1 = Manual, Failsafe Output
Reset SP Program (to begin)	179	11	0 = Disable 1 = Via Keyboard 2 = Rerun
Segment #1 Ramp Time	057	18	99.59 (0-99 Hrs:0-59 Min) or 0 to 999 (Degrees/Minute)
Segment #2 Soak Setpoint Value	058	18	Within Setpoint Limits
Segment #2 Soak Time	059	18	99.59 (0-99 Hrs:0-59 Min)

5.10 Configuration Parameters - UDC2300, Continued

**Setpoint
ramp/rate/program,
continued**

Table 5-16 Setup Group – SP Ramp, Rate, or SP Program, Continued

Parameter Description	Identifying Code	Format Code	Range or Selection
Segment #3 Ramp Time	060	18	99.59 (0-99 Hrs:0-59 Min) or 0 to 999 (Degrees/Minute)
Segment #4 Soak Setpoint Value	061	18	Within Setpoint Limits
Segment #4 Soak Time	062	18	99.59 (0-99 Hrs:0-59 Min)
Segment #5 Ramp Time	063	18	99.59 (0-99 Hrs:0-59 Min) or 0 to 999 (Degrees/Minute)
Segment #6 Soak Setpoint Value	064	18	Within Setpoint Limits
Segment #6 Soak Time	065	18	99.59 (0-99 Hrs:0-59 Min)
Segment #7 Ramp Time	066	18	99.59 (0-99 Hrs:0-59 Min) or 0 to 999 (Degrees/Minute)
Segment #8 Soak Setpoint Value	067	18	Within Setpoint Limits
Segment #8 Soak Time	068	18	99.59 (0-99 Hrs:0-59 Min)
Segment #9 Ramp Time	069	18	99.59 (0-99 Hrs:0-59 Min) or 0 to 999 (Degrees/Minute)
Segment #10 Soak Setpoint Value	070	18	Within Setpoint Limits
Segment #10 Soak Time	071	18	99.59 (0-99 Hrs:0-59 Min)
Segment #11 Ramp Time	072	18	99.59 (0-99 Hrs:0-59 Min) or 0 to 999 (Degrees/Minute)
Segment #12 Soak Setpoint Value	073	18	Within Setpoint Limits
Segment #12 Soak Time	074	18	99.59 (0-99 Hrs:0-59 Min)

5.10 Configuration Parameters - UDC2300, Continued

Accutune

Table 5-17 lists all the I.D. codes and ranges or selections for the function parameters in setup group “ACCUTUNE.”

Table 5-17 Setup Group – Adaptive Tune

Parameter Description	Identifying Code	Format Code	Range or Selection
Fuzzy Overshoot Suppression	193	11	0 = Disabled 1 = Enabled
Accutune Enable	152	11	0 = Accutune disabled 1 = Tune
Accutune Error (Read only)	151	11	0 = None 3 = Process Identification failed 4 = Accutune aborted on command 5 = Running

5.10 Configuration Parameters - UDC2300, Continued

Algorithm

Table 5-18 lists all the I.D. codes and ranges or selections for the Function Parameters in setup group “ALGORITHM.”

Table 5-18 Setup Group – Algorithm

Parameter Description	Identifying Code	Format Code	Range or Selection
Control Algorithm Selection (Selection here will affect I.D. code 160 in “Output Algorithms.”)	128	11	0 = ON/OFF† 1 = PID-A 2 = PID-B 3 = PD-A with Manual Reset 4 = Three Position Step
Output Algorithm	160	11	0 = Time Simplex Relay 1 1 = Time Simplex Relay 2 2 = Current Simplex 3 = TPSC 4 = Time Duplex 5 = Current Duplex 6 = Current Time Duplex 7 = Time Current Duplex
Relay Cycle Time Increments	190	11	0 = 1 second increments 1 = 1/3 second increments

5.10 Configuration Parameters - UDC2300, Continued

Input 1

Table 5-19 lists all the I.D. codes and ranges or selections for the function parameters in setup group “INPUT 1.”

Table 5-19 Setup Group – Input 1

Parameter Description	Identifying Code	Format Code	Range or Selection
Decimal Point Location	155	11	0 = XXXX – Fixed 1 = XXX.X – Floating decimal point to one 2 = XX.XX – Floating decimal point to two
Temperature Units	129	11	0 = °F 1 = °C 2 = None

5.10 Configuration Parameters - UDC2300, Continued

Input 1, continued

Table 5-19 Setup Group – Input 1, Continued

Parameter Description	Identifying Code	Format Code	Range or Selection
Input 1 Type	168	11	<p> 1 = B TC 2 = E TC H 3 = E TC L 4 = J TC H 5 = J TC L 6 = K TC H 7 = K TC L 8 = NNM H 9 = NNM L 10 = NM90 H 11 = NM90 L 12 = Nicrosil TC 13 = R TC 14 = S TC 15 = T TC H 16 = T TC L 17 = W TC H 18 = W TC L 19 = 100 PT RTD 20 = 100 PT LO RTD 21 = 200 PT RTD 22 = 500 PT RTD 23 = Radiamatic RH 24 = Radiamatic RI 25 = 0-20 mA* 26 = 4-20 mA* 27 = 0-10 mV* 28 = 0-50 mV* 29 = 0-5 Vdc 30 = 1-5 Vdc* 31 = 0-10 Vdc* 32 = Unused 33 = 100 M </p> <p>*Limit: Non-FM only</p> <div style="border: 1px solid black; padding: 5px;"> <p>NOTICE</p> <p>Changing the Input Type will result in the loss of Field Calibration values and will restore the Factory Calibration values.</p> </div>

5.10 Configuration Parameters - UDC2300, Continued

Input 1, continued

Table 5-19 Setup Group – Input 1, Continued

Parameter Description	Identifying Code	Format Code	Range or Selection
Input 1 Transmitter Characterization	169	11	0 = B TC 1 = E TC H 2 = E TC L 3 = J TC H 4 = J TC L 5 = K TC H 6 = K TC L 7 = NNM TC H 8 = NNM TC L 9 = NM90 H 10 = NM90 L 11 = Nicrosil TC 12 = R TC 13 = S TC 14 = T TC H 15 = T TC L 16 = W TC H 17 = W TC L 18 = 100 PT RTD 19 = 100 PT LO RTD 20 = 200 PT RTD 21 = 500 PT RTD 22 = Radiamatic RH 23 = Radiamatic RI 24 = Linear 25 = Square Root
Input 1 High Range Value	029	18	–999. to 9999. Engineering Units (Linear types only)
Input 1 Low Range Value	030	18	–999 to 9999. Engineering Units (Linear types only)
Input 1 Ratio	106	18	–20.00 to 20.00
Input 1 Bias	107	18	–999 to 9999. Engineering Units
Input 1 Filter	042	18	0 to 120 seconds
Burnout (Open Circuit Detection)	164	11	0 = None 1 = Upscale 2 = Downscale 3 = NOFS (No Failsafe) Limit: 0 = Downscale 1 = Upscale <i>Read only, Writes illegal</i>

5.10 Configuration Parameters - UDC2300, Continued

Input 1, continued

Table 5-19 Setup Group – Input 1, Continued

Parameter Description	Identifying Code	Format Code	Range or Selection
Display	186	11	0 = SP (setpoint) 1 = PRY (PV with label) 2 = PRN (PV without label)
Language (Displays)	192	11	0 = English 1 = French 2 = German 3 = Spanish 4 = Italian
Power Frequency	166	11	0 = 60 Hertz 1 = 50 Hertz

5.10 Configuration Parameters - UDC2300, Continued

Input 2

Table 5-20 lists all the I.D. codes and ranges or selections for the function parameters in setup group “INPUT 2.”

Table 5-20 Setup Group – Input 2

Parameter Description	Identifying Code	Format Code	Range or Selection
Input 2 Type	170	11	<p>1 to 24 = Unused 0 = Disable 25 = 0-20 mA 26 = 4-20 mA 29 = 0-5 Vdc 30 = 1-5 Vdc 31 = Unused 32 = Slidewire</p> <div style="border: 1px solid black; padding: 5px;"> <p>NOTICE Changing the Input Type will result in the loss of Field Calibration values and will restore the Factory Calibration values.</p> </div>
Input 2 Transmitter Characterization	171	11	<p>0 = B TC 1 = E TC H 2 = E TC L 3 = J TC H 4 = J TC L 5 = K TC H 6 = K TC L 7 = NNM TC H 8 = NNM TC L 9 = NM90 H 10 = NM90 L 11 = Nicrosil TC 12 = R TC 13 = S TC 14 = T TC H 15 = T TC L 16 = W TC H 17 = W TC L 18 = 100 PT RTD 19 = 100 PT LO RTD 20 = 200 PT RTD 21 = 500 PT RTD 22 = Radiamatic RH 23 = Radiamatic RI 24 = Linear 25 = Square Root</p>
Input 2 High Range Value	035	18	–999. to 9999. Engineering Units

5.10 Configuration Parameters - UDC2300, Continued

Input 2, continued

Table 5-20 Setup Group – Input 2, Continued

Parameter Description	Identifying Code	Format Code	Range or Selection
Input 2 Low Range Value	036	18	–999 to 9999. Engineering Units
Input 2 Ratio	037	18	–20.00 to 20.00
Input 2 Bias	038	18	–999 to 9999. Engineering Units
Input 2 Filter	043	18	0 to 120 seconds

5.10 Configuration Parameters - UDC2300, Continued

Control

Table 5-21 lists all the I.D. codes and ranges or selections for the function prompts in setup group “CONTROL.”

Table 5-21 Setup Group – Control

Parameter Description	Identifying Code	Format Code	Range or Selection												
Tuning Parameter Selection	172	11	0 = One set only 1 = 2 sets keyboard selected 2 = 2 sets with PV automatic switchover 3 = 2 sets with setpoint (SP) automatic switchover												
Automatic Switchover Value (used with 172 selection 2 or 3)	056	18	Within the PV Range in engineering units												
Local Setpoint Source (Number of LSP's)	173	11	0 = One Local Setpoint 1 = Two Local Setpoints (disables RSP)												
Power Up Mode Recall	130	11	<table border="0"> <thead> <tr> <th>Control Mode</th> <th>Setpoint Mode</th> </tr> </thead> <tbody> <tr> <td>0 = MAN</td> <td>LSP1</td> </tr> <tr> <td>1 = AUTO</td> <td>LSP1</td> </tr> <tr> <td>2 = AUTO</td> <td>Last RSP</td> </tr> <tr> <td>3 = LAST</td> <td>Last SP</td> </tr> <tr> <td>4 = LAST</td> <td>Last local SP</td> </tr> </tbody> </table>	Control Mode	Setpoint Mode	0 = MAN	LSP1	1 = AUTO	LSP1	2 = AUTO	Last RSP	3 = LAST	Last SP	4 = LAST	Last local SP
Control Mode	Setpoint Mode														
0 = MAN	LSP1														
1 = AUTO	LSP1														
2 = AUTO	Last RSP														
3 = LAST	Last SP														
4 = LAST	Last local SP														
RSP Source	131	11	0 = None 1 = Remote Setpoint via Input 2												
Setpoint Tracking	138	11	0 = None 1 = LSP = PV (when in Manual) 2 = LSP = RSP (when switched)												
Control Setpoint High Limit	007	18	0 % to 100 % of PV (engineering units)												
Control Setpoint Low Limit	008	18	0 % to 100 % of PV (engineering units)												

5.10 Configuration Parameters - UDC2300, Continued

Control, continued

Table 5-21 Setup Group – Control, Continued

Parameter Description	Identifying Code	Format Code	Range or Selection
Control Output Direction/Alarm Outputs	135	11	0 = Direct Action Alarm Output energized 1 = Direct Action Alarm Output de-energized 2 = Reverse Action Alarm Output energized 3 = Reverse Action Alarm Output de-energized
High Output Limit	014	18	–5 % to 105 % of output
Low Output Limit	015	18	–5 % to 105 % of output
Output Deadband	018	18	–5 % to +25.0 % Time Duplex
	020	18	0.5 % to 5.0 % 3 position step
Output Hysteresis	019	18	0.0 % to 100.0 % of PV
Failsafe Mode	213	11	0 = Latching 1 = Non latching
Failsafe Output Level	040	18	0 % to 100 %
Proportional Band Units	148	11	0 = Gain 1 = Proportional Band
Reset Units	149	11	0 = Minutes 1 = RPM

5.10 Configuration Parameters - UDC2300, Continued

Communications Table 5-22 lists all the I.D. codes and ranges or selections for the function parameters in setup group “COM.”

Table 5-22 Setup Group – Communications

Parameter Description	Identifying Code	Format Code	Range or Selection
Shed Enable	187	11	0 = Shed disabled 1 = Shed enabled
Shed Time	154	11	0 = No Shed 1 = 255 sample periods
Shed Mode and Output	162	11	0 = Last Mode and Last Output 1 = Manual Mode, Last Output 2 = Manual Mode, Failsafe Output 3 = Automatic Mode
Shed Setpoint Recall	163	11	0 = To Last Local Setpoint used 1 = Last Setpoint prior to Shed
Communication Override Units	161	11	0 = Percent 1 = Engineering Units
Computer Setpoint Ratio	021	18	-20.00 to 20.00
Computer Setpoint Bias	022	18	-999 to 9999.

5.10 Configuration Parameters - UDC2300, Continued

Alarms

Tables 5-23 lists all the I.D. codes and ranges or selections for the function parameters in setup group “ALARMS.”

Table 5-23 Setup Group – Alarms

Parameter Description	Identifying Code	Format Code	Range or Selection
Alarm 1 Setpoint 1 Value	009	18	Within the range of selected parameter or PV span for deviation alarm
Alarm 1 Setpoint 2 Value	010	18	Within the range of selected parameter or PV span for deviation alarm
Alarm 2 Setpoint 1 Value	011	18	Within the range of selected parameter or PV span for deviation alarm
Alarm 2 Setpoint 2 Value	012	18	Within the range of selected parameter or PV span for deviation alarm
Alarm 1 Setpoint 1 Type	140	11	0 = None 1 = Input 1 2 = Input 2 3 = PV 4 = Deviation 5 = Output 6 = Alarm on Shed 7 = SP Event On 8 = SP Event Off 9 = Manual 10 = Remote Setpoint 11 = Failsafe 12 = PV Rate of Change 13 = Alarm on Digital Input 14 = Alarm based on SP2 15 = Loop Break Alarm Limit Controller: 0 = None 1 = PV 2 = Deviation 3 = Shed
Alarm 1 Setpoint 2 Type	142	11	Same as 140
Alarm 2 Setpoint 1 Type	144	11	Same as 140

5.10 Configuration Parameters - UDC2300, Continued

Alarms, continued

Table 5-23 Setup Group – Alarms, Continued

Parameter Description	Identifying Code	Format Code	Range or Selection
Alarm 2 Setpoint 2 Type	146	11	Same as 140
Alarm 1 Setpoint 1 Event	141	11	0 = Low Alarm 1 = High Alarm
Alarm 1 Setpoint 2 Event	143	11	0 = Low Alarm 1 = High Alarm
Alarm 2 Setpoint 1 Event	145	11	0 = Low Alarm 1 = High Alarm
Alarm 2 Setpoint 2 Event	147	11	0 = Low Alarm 1 = High Alarm
Alarm Hysteresis	041	18	0.0 % to 100.0 % of output or span
Alarm Latching for Output 1	200	11	0 = Non Latching 1 = Latching
Alarm Blocking	201	11	0 = Disabled 1 = Block Alarm 1 2 = Block Alarm 2 3 = Block Both Alarms

Section 6 – Operating the Controller with Communications Option

6.1 Operation

Introduction During communications the controller can operate in various modes and the operator can assume manual control of the output. There are various indications of these actions.

Monitor mode During “Monitor Mode” the UDC will control normally with operator access allowed at the keyboard. See the individual Product Manual.

Slave mode During “Slave” operation:

- Configuration data may not be changed via the front keyboard.
- MAN annunciator is OFF.
- The controller will use override data provided at the computer.

Emergency manual During “Slave” operation the operator can assume manual control of the output (Emergency Manual). The procedure in Table 6-1 tells you how to start and stop emergency manual.

Table 6-1 Emergency Manual Procedure

Operation	Action
Start Emergency Manual	<ul style="list-style-type: none"> • Press [MAN/AUTO]. • MAN annunciator comes ON. • Press [▲] or [▼] to position the output manually.
End Emergency Manual	<ul style="list-style-type: none"> • Press [MAN/AUTO] key - this second press ends the Emergency Manual operation. The controller reverts to “Slave” mode, Manual output. • MAN annunciator goes OFF.

Overriding setpoint or PV indication When setpoint or PV are overridden, a blinking “CSP” appears in the upper display.

Section 7 – ASCII Conversion Table

7.1 Overview

Overview Table 7-1 lists the Hex and Decimal designations for all the ASCII Character Codes.

Table 7-2 is a Hex, Decimal, and Binary conversion table.

Table 7-1 ASCII Character Codes

Control				Figures			Uppercase			Lowercase		
ASCII	HEX	DEC	ASCII	HEX	DEC	ASCII	HEX	DEC	ASCII	HEX	DEC	
NUL (CTL @)	00	0	space	20	32	@	40	64	\	60	96	
SOH (CRL A)	01	1	!	21	33	A	41	65	a	61	97	
STX (CTL B)	02	2	"	22	34	B	42	66	b	62	98	
ETX (CTL C)	03	3	#	23	35	C	43	67	c	63	99	
EOT (CTL D)	04	4	\$	24	36	D	44	68	d	64	100	
ENQ (CTL E)	05	5	%	25	37	E	45	69	e	65	101	
ACK (CTL F)	06	6	&	26	38	F	46	70	f	66	102	
BEL (CTL G)	07	7	'	27	39	G	47	71	g	67	103	
BS (CTL H)	08	8	(28	40	H	48	72	h	68	104	
HT (CTL I)	09	9)	29	41	I	49	73	i	69	105	
LF (CTL J)	0A	10	*	2A	42	J	4A	74	j	6A	106	
VT (CTL K)	0B	11	+	2B	43	K	4B	75	k	6B	107	
FF (CTL L)	0C	12	,	2C	44	L	4C	76	l	6C	108	
CR (CTL M)	0D	13	-	2D	45	M	4D	77	m	6D	109	
SO (CTL N)	0E	14	.	2E	46	N	4E	78	n	6E	110	
SI (CTL O)	0F	15	/	2F	47	O	4F	79	o	6F	111	
DLE (CTL P)	10	16	0	30	48	P	50	80	p	70	112	
DC1 (CTL Q)	11	17	1	31	49	Q	51	81	q	71	113	
DC2 (CTL R)	12	18	2	32	50	R	52	82	r	72	114	
DC3 (CTL S)	13	19	3	33	51	S	53	83	s	73	115	
DC4 (CTL T)	14	20	4	34	52	T	54	84	t	74	116	
NAK (CTL U)	15	21	5	35	53	U	55	85	u	75	117	
SYN (CTL V)	16	22	6	36	54	V	56	86	v	76	118	
ETB (CTL W)	17	23	7	37	55	W	57	87	w	77	119	
CAN (CTL X)	18	24	8	38	56	X	58	88	x	78	120	
EM (CTL Y)	19	25	9	39	57	Y	59	89	y	79	121	
SUB (CTL Z)	1A	26	:	3A	58	Z	5A	90	z	7A	122	
ESC (CTL [)	1B	27	;	3B	59	[5B	91	{	7B	123	
FS (CTL \)	1C	28	<	3C	60	\	5C	92		7C	124	
GS (CTL])	1D	29	=	3D	61]	5D	93	}	7D	125	
RS (CTL ^)	1E	30	>	3E	62	^	5E	94	~	7E	126	
US (CTL _)	1F	31	?	3F	63	_	5F	95	DEL	7F	127	

7.1 Overview, Continued

Overview, continued

Table 7-2 Hexadecimal to Binary

HEX	DEC	BINARY	HEX	DEC	BINARY	HEX	DEC	BINARY	HEX	DEC	BINARY
0	0	0000	4	4	0100	8	8	1000	C	12	1100
1	1	0001	5	5	0101	9	9	1001	D	13	1101
2	2	0010	6	6	0110	A	10	1010	E	14	1110
3	3	0011	7	7	0111	B	11	1011	F	15	1111

Section 8 – Cable Specifications

8.1 Introduction

Introduction Table 8-1 lists the cable specifications for 2000 feet or 5000 feet cabled used for wiring the communications link.

Table 8-1 Cable Specifications

	2000 Foot Cable	5000 Foot Cable
Cable Type	Two-conductor stranded (twin axial), 100 % shield, 120 ohms, #25 AWG, polyethylene insulated, with aluminum-mylar shield, drain wire, and vinyl jacket.	Two-conductor stranded (twin axial), 100 % shield, 150 ohms, #25 AWG, datalene insulated, with aluminum-mylar shield, drain wire, and vinyl or teflon jacket.
Commercial Equivalent	Belden Corporation type 9271 Twinax	Belden Corporation type 9182 Twinax OR Belden Corporation type 89128 Twinax
Electrical Characteristics		
Characteristic Impedance	124 ohms	150 ohms
Resistance: Center Conductors Shield	104.3 ohms per kilometer 39.4 ohms per kilometer	49.2 ohms per kilometer 15 ohms per kilometer
Capacitance	40 picofarads per meter	28.9 picofarads per meter
Attenuation	at 1 MHz – 2 db per 100 meters at 10 MHz – 5.6 db per 100 meters	at 1 MHz – .98 db per 100 meters at 10 MHz – 4.3 db per 100 meters
Mechanical Characteristics		
Center Conductor Insulation	Polyethylene	Datalene®
Jack Composition	Vinyl (PVC)	Vinyl (PVC) (Belden 9182) or Teflon (Belden 89182)
Jacket Outer Diameter	6.1 millimeters	8.9 millimeters
Environmental Limits		
Temperature	–20 °C to 80 °C (–4 °F to 176 °F)	–20 °C to 80 °C (–4 °F to 176 °F)
Relative Humidity	5 % to 95 %	5 % to 95 %
Distance Limits	625 meters (2000 feet) Cable must be terminated at each end with a 124 ohm ± 10 % 1/4 watt resistor.	1524 meters (5000 feet) Cable must be terminated at each end with a 150 ohm ± 10 % 1/4 watt resistor.
Maximum Number of Devices	15	15
Baud Rate	19.2K	19.2K

Index

A

Alarm Status, 24
Analog Parameter Request Format, 40
Analog Parameter Response Format, 41

B

Baud Rate, 14
Black Box converter, 7
Black Box Converter, 6
busy response, 19
Busy response, 47, 50

C

Calculating the Checksum, 28
Carriage Return/Line Feed, 22
Checksum, 2
checksum calculation, 29
Checksum Calculation, 32
Checksum calculation example, 29
Checksum Field, 22
Checksum Protocol, 27
Communication Units, 15
Communications Address, 13
Communications option connections, 11
Communications Setpoint Bias, 15
Communications Setpoint Ratio, 15
Communications State, 13
Configurable parameters, 13
Configuration Parameters, 67
Configuration protocol, 2
Configuring the WESTERMO Converter, 10
Controller Address, 2
Converters, 6

D

Data Field, 22, 24
Data Type Field, 22
Digital Parameter Request Format, 43
Digital Parameter Response Format, 44

E

Electrical noise protection, 5
Establishing Communications and Testing, 13

F, G, H

Field Upgrade, 3
Floating Point Big Endian, 14
Floating Point Big Endian with byte-swapped, 14
Floating Point Little Endian, 14
Floating Point Little Endian with byte-swapped, 14

I, J

Installation, 5
Is Ready response, 48, 51

K

Keyboard Configuration, 2

L

Link devices terminal connections, 8, 10
Local Setpoint/PID Selection/Setpoint Ramp Status, 64
Loopback, 2, 34
Loopback message exchange, 34
lost message, 36

M, N

Message Exchange Protocols, 2
Message Exchanges, 1, 19
Miscellaneous Read Only's, 57
Monitor or slave mode, 1

O

Optional Checksum Field, 24
Overview, 1

P, Q

Parity, 14
Programming Your Computer, 18
Protocol Class and Operation Code, 21
Protocol Field, 21
PV or Setpoint Override Selections, 62

R

Read Analog Parameter Message Exchange, 42
Read Analog Parameters, 40
Read Digital Parameter Message Exchange, 44
Read Digital Parameters, 43
Read operations, 39
Read Options Status, 56
Read request, 19
Reading Control Data, 55
Reading or Changing the Output, 63
Ready message, 19
Ready request, 47, 51
Recovering from Communications Failures, 36
Request Format for Checksum Protocol, 27
Request message, 20
Request Message Status Code, 24
Response message, 23

Index

S

Setpoints, *59*
Shed, *13, 33*
Shed controller mode and output level, *33*
Shed Controller Mode and Output Level, *14*
Shed setpoint recall, *33*
Shed Setpoint Recall, *15*
Shed time, *33*
Shed Time, *13*
Station Address, *21*
Status Codes, *25, 26*
Switch Settings for Westermo Converter, *10*
Synchronization, *13*

T

Terminal Connections for Westermo Converters, *10*
time a message exchange, *37*
Timing message exchanges, *37*
Timing routine, *38*
Transaction states, *39*
TX Delay, *14*

U, V

UDC State and Mode, *24*
UDC State and Mode, *21*
UDC Status Code, *24*

UDC2300
error status codes, *58*
UDC2300 canceling the override, *62*
UDC2300 Set Up Group
ACCUTUNE, *72*
ALARMS, *83*
ALGORITHM, *73*
COM, *82*
CONTROL, *80*
INPUT 1, *74*
INPUT 2, *78*
SP RAMP/RATE/PROGRAM, *70*
TUNING, *68*
Using a Computer Setpoint, *60*

W, X, Y, Z

Westermo converter
Configuration and wiring, *9*
Westermo Converter, *6*
Westermo wiring connections, *10*
Wiring the Black Box converter and the link, *7*
Wiring the Westermo converter and the link, *9*
Word/Byte Order, *14*
Write Analog Parameters, *46*
write configuration or override data, *19*
Write Digital Parameters, *50*
Write message exchange, *45*
Write Operations, *45*

HONEYWELL SERVICE CENTERS

ARGENTINA

HONEYWELL S.A.I.C.
BELGRANO 1156
BUENOS AIRES
ARGENTINA
Tel. : 54 1 383 9290

BULGARIA

HONEYWELL EOOD
14, Iskarsko Chausse
POB 79
BG- 1592 Sofia
BULGARIA
Tel : 359-791512/ 794027/ 792198

GERMANY

HONEYWELL AG
Kaiserleistrasse 39
D-63067 OFFENBACH
GERMANY
Tel. : 49 69 80 640

ASIA PACIFIC

HONEYWELL ASIA PACIFIC Inc.
Room 3213-3225
Sun Kung Kai Centre
N° 30 Harbour Road
WANCHAI
HONG KONG
Tel. : 852 829 82 98

CANADA

HONEYWELL LIMITED
THE HONEYWELL CENTRE
529 Mc Nicoll Avenue
M2H 2C9 NORTH YORK,
ONTARIO
CANADA
Tel. : 416 502 5200

HUNGARY

HONEYWELL Kft
Gogol u 13
H-1133 BUDAPEST
HUNGARY
Tel. : 36 1 451 43 00

AUSTRALIA

HONEYWELL LIMITED
5 Thomas Holt Drive
North Ryde Sydney
NSW AUSTRALIA 2113
Tel. : 61 2 353 7000

CZECH REPUBLIC

HONEYWELL, Spol.s.r.o.
Budejovicka 1
140 21 Prague 4
Czech Republic
Tel. : 42 2 6112 3434

ICELAND

HONEYWELL
Hataekni .hf
Armuli 26
PO Box 8336
128 reykjavik
Iceland
Tel : 354 588 5000

AUSTRIA

HONEYWELL AUSTRIA G.m.b.H.
Handelskai 388
A1020 VIENNA
AUSTRIA
Tel. : 43 1 727 800

DENMARK

HONEYWELL A/S
Automatikvej 1
DK 2860 Soeborg
DENMARK
Tel. : 45 39 55 56 58

ITALY

HONEYWELL S.p.A.
Via P. Gobetti, 2/b
20063 Cernusco Sul Naviglio
ITALY
Tel. : 39 02 92146 1

BELGIUM

HONEYWELL S.A.
3 Avenue de Bourget
B-1140 BRUSSELS
BELGIUM
Tel. : 32 2 728 27 11

FINLAND

HONEYWELL OY
Ruukintie 8
FIN-02320 ESPOO 32
FINLAND
Tel. : 358 0 3480101

MEXICO

HONEYWELL S.A. DE CV
AV. CONSTITUYENTES 900
COL. LOMAS ALTAS
11950 MEXICO CITY
MEXICO
Tel : 52 5 259 1966

BRAZIL

HONEYWELL DO BRAZIL AND CIA
Rua Jose Alves Da Chunha
Lima 172
BUTANTA
05360.050 SAO PAULO SP
BRAZIL
Tel. : 55 11 819 3755

FRANCE

HONEYWELL S.A.
Bâtiment « le Mercury »
Parc Technologique de St Aubin
Route de l'Orme (CD 128)
91190 SAINT-AUBIN
FRANCE
Tel. from France: 01 60 19 80 00
From other countries: 33 1 60 19 80 00

THE NETHERLANDS

HONEYWELL BV
Laaderhoogtweg 18
1101 EA AMSTERDAM ZO
THE NETHERLANDS
Tel : 31 20 56 56 911

HONEYWELL SERVICE CENTERS

NORWAY

HONEYWELL A/S
Askerveien 61
PO Box 263
N-1371 ASKER
NORWAY
Tel. : 47 66 76 20 00

POLAND

HONEYWELL Sp.z.o.o
Ul Domainewska 41
02-672 WARSAW
POLAND
Tel. : 48 22 606 09 00

PORTUGAL

HONEYWELL PORTUGAL LDA
Edificio Suecia II
Av. do Forte nr 3 - Piso 3
2795 CARNAXIDE
PORTUGAL
Tel. : 351 1 424 50 00

REPUBLIC OF IRELAND

HONEYWELL
Unit 1
Robinhood Business Park
Robinhood Road
DUBLIN 22
Republic of Ireland
Tel. : 353 1 4565944

REP. OF SINGAPORE

HONEYWELL PTE LTD
BLOCK 750E CHAI CHEE ROAD
06-01 CHAI CHEE IND. PARK
1646 SINGAPORE
REP. OF SINGAPORE
Tel. : 65 2490 100

REPUBLIC OF SOUTH AFRICA

HONEYWELL
Southern Africa
PO BOX 138
Milnerton 7435
REPUBLIC OF SOUTH AFRICA
Tel. : 27 11 805 12 01

ROMANIA

HONEYWELL Office
Bucharest
147 Aurel Vlaicu Str., Sc.Z.,
Apt 61/62
R-72921 Bucharest
ROMANIA
Tel : 40-1 211 00 76/ 211 79 43

RUSSIA

HONEYWELL INC
4th Floor Administrative
Building of AO "Luzhniki"
Management
24 Luzhniki
119048 Moscow
RUSSIA
Tel : 7 095 796 98 00/01

SLOVAKIA

HONEYWELL Ltd
Mlynske nivy 73
PO Box 75
820 07 BRATISLAVA 27
SLOVAKIA
Tel. : 421 7 52 47 400/425

SPAIN

HONEYWELL S.A
Factory
Josefa Valcarcel, 24
28027 MADRID
SPAIN
Tel. : 34 91 31 3 61 00

SWEDEN

HONEYWELL A.B.
S-127 86 Skarholmen
STOCKHOLM
SWEDEN
Tel. : 46 8 775 55 00

SWITZERLAND

HONEYWELL A.G.
Hertistrasse 2
8304 WALLISELLEN
SWITZERLAND
Tel. : 41 1 831 02 71

TURKEY

HONEYWELL Otomasyon ve
Kontrol
Sistemlen San ve Tic A.S.
(Honeywell Turkey A.S.)
Emirhan Cad No 144
Barbaros Plaza C. Blok Kat 18
Dikilitas 80700 Istanbul
TURKEY
Tel : 90-212 258 18 30

UNITED KINGDOM

HONEYWELL
Unit 1,2 &4 Zodiac House
Calleva Park
Aldermaston
Berkshire RG7 8HW
UNITED KINGDOM
Tel : 44 11 89 81 95 11

U.S.A.

HONEYWELL INC.
INDUSTRIAL CONTROLS DIV.
1100 VIRGINIA DRIVE
PA 19034-3260 FT. WASHINGTON
U.S.A.
Tel. : 215 641 3000

VENEZUELA

HONEYWELL CA
APARTADO 61314
1060 CARACAS
VENEZUELA
Tel. : 58 2 239 0211

Honeywell

Sensing and Control
Honeywell
11 West Spring Street
Freeport, IL 61032